

Thrane IP Handset

User manual

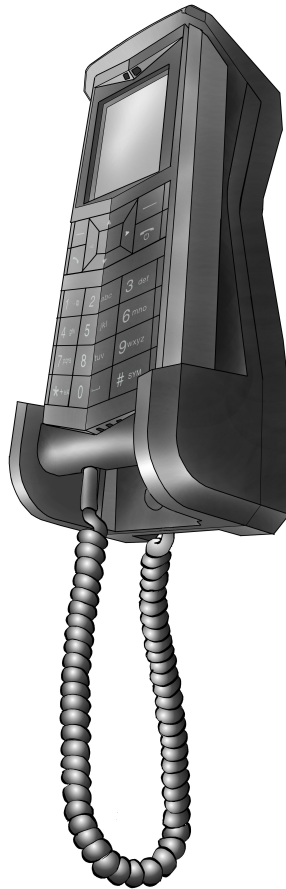

Thrane IP Handset

User Manual

Document number: 98-126059-J

Release date: January 19, 2018

Disclaimer

Any responsibility or liability for loss or damage in connection with the use of this product and the accompanying documentation is disclaimed by Thrane & Thrane A/S. The information in this manual is provided for information purposes only, is subject to change without notice and may contain errors or inaccuracies. Manuals issued by Thrane & Thrane A/S are periodically revised and updated. Anyone relying on this information should acquire the most current version e.g. from www.cobham.com/satcom, **Cobham SYNC Partner Portal**, or from the distributor. Thrane & Thrane A/S is not responsible for the content or accuracy of any translations or reproductions, in whole or in part, of this manual from any other source. In the event of any discrepancies, the English version shall be the governing text.

Thrane & Thrane A/S is trading as Cobham SATCOM.

Copyright © 2018 Thrane & Thrane A/S. All rights reserved.

Manufacturer address

Thrane & Thrane A/S, Lundtoftegaardsvej 93 D, DK-2800, Kgs. Lyngby, Denmark

Trademark Acknowledgements

- **Inmarsat** is a registered trademark of the International Maritime Satellite Organisation (IMSO) and is licensed by IMSO to Inmarsat Limited and Inmarsat Ventures plc.
- Inmarsat's product names are trademarks or registered trademarks of Inmarsat.
- Other product and company names mentioned in this manual may be trademarks or trade names of their respective owners.

Typography

In this manual, typography is used as indicated below:

Bold is used for the following purposes:

- To emphasize words.
Example: "Do **not** touch the antenna".
- To indicate what the user should select in the user interface.
Example: "Select **Settings** > **Display**".

Italic is used to emphasize the paragraph title in cross-references.

Example: "For further information, see *Connecting Cables* on page...".

Safety Summary

The following general safety precautions must be observed during all phases of operation, service and repair of this equipment. Failure to comply with these precautions or with specific warnings elsewhere in this manual violates safety standards of design, manufacture and intended use of the equipment. Thrane & Thrane A/S assumes no liability for the customer's failure to comply with these requirements.

DO NOT OPERATE IN AN EXPLOSIVE ATMOSPHERE

Do not operate the IP Handset in the presence of flammable gases or fumes. Operation of any electrical equipment in such an environment constitutes a definite safety hazard.

KEEP AWAY FROM LIVE CIRCUITS

Operating personnel must not remove equipment covers. Component replacement and internal adjustment must be made by qualified maintenance personnel. Do not replace components with the cable connected. Always disconnect power and discharge circuits before touching them.

DISPOSAL

Old electrical and electronic equipment marked with this symbol can contain substances hazardous to human beings and the environment. Never dispose these items together with unsorted municipal waste (household waste). In order to protect the environment and ensure the correct recycling of old equipment as well as the re-utilization of individual components, use either public collection or private collection by the local distributor of old electrical and electronic equipment marked with this symbol.



Contact the local distributor for information about what type of return system to use.

About the Manual

Intended readers

This manual is a user manual for the Thrane IP Handset. The readers of the manual include anyone who is using or intends to use the IP Handset. No specific skills are required to operate the IP Handset. However, it is important that you observe all safety requirements listed in the beginning of this manual, and operate the handset according to the guidelines in this manual.

Manual overview

This manual has the following chapters:

- **Introduction** contains an overview and a brief description of the IP Handset.
- **Get started** explains how to connect and start up the handset and gives an overview of the display and keypad. It also contains a short guide to initial configuration and to making the first call.
- **To use the IP Handset** describes how to use and configure the handset and explains the display menus.
- **To use the web server** explains how to use the built-in web server of the IP Handset.
- **Service & maintenance** contains guidelines for maintenance of the handset, a short troubleshooting guide and gives information on where to get further help if needed.

This manual may not always reflect the latest software functionality of your IP Handset. To obtain the latest version of the manual, go to www.cobham.com/satcom, enter the **Cobham SYNC Partner Portal** and download the latest version, or acquire it from your distributor.

Related documents

The following related documentation is referred to in this manual:

Title	Document number
Voice Distress (Non-SOLAS) User manual	98-133687

Table of Contents

	Safety Summary	iii
	About the Manual	iv
Chapter 1	Introduction	
	Welcome	1
	Your IP Handset	1
	Functions	1
	The IP Handset	2
	Features	3
Chapter 2	Get started	
	Get started with the IP Handset	5
	Introduction	5
	Connectors on the handset	6
	Connect the cables to the IP cradle	6
	Install the cradle	8
	Connect the IP Handset to a BGAN terminal	9
	Start up the IP Handset	10
	Establish a connection using BGAN terminal	11
	To use a BGAN terminal	11
	To establish a connection	11
	Change user name and password for an IP Handset	14
	Make the first call	16
	IP Handset keypad and display	17
	The keypad	17
	The display	23
Chapter 3	To use the IP Handset	
	User interfaces	29

IP Handset functions	30
Handle calls	30
Make a call using a BGAN terminal	38
Use the IP Handset for Voice Distress	39
Quick settings	39
How to enter text in the IP Handset	42
To use a headset	42
IP Handset menus	44
Call log	45
Contacts	47
Status	49
Network	50
Settings	51
SIP telephony and profiles	62
Information from the BGAN terminal	68

Chapter 4 To use the web server

Introduction to the web server	75
Browser settings	76
To use the web server	79
The Home page	79
Contacts	80
Call log	81
SIP settings	82
To upload firmware	84
Import and Export settings	85
Help and diagnostics report	87

Chapter 5 Service & maintenance

Get support	89
Maintenance tasks	90
Software update	90
Clean the IP Handset	90
Disposal of the IP Handset	90

	Troubleshooting guide	91
App. A	Technical specifications	
	IP Handset specifications	93
	IP Handset outline dimensions	95
	IP cradle outline dimensions	97
App. B	Conformity	
	Thrane IP Handset, wired	99
	CE (LVD & EMC)	99
	FCC	99
Glossary	101
Index	105

Introduction

Welcome

Congratulations on the purchase of your IP Handset!

The IP Handset communicates using Voice over Internet Protocol (VoIP), which means that voice conversations are routed over the Internet or through an IP-based network.

Your IP Handset

Functions

The IP Handset is used for making phone calls over an IP based network.

The IP Handset has some BGAN terminal control functions. If configured as handset with the local number 0501, you can use the handset to start and stop data connections (background or streaming) for all network user groups.

To improve overall system overview the IP Handset displays active, critical alarms from the BGAN terminal to keep you informed about the status of the BGAN terminal.

The handset is designed specifically for use in harsh environments and it is dust proof and splash proof. Excellent sound quality is achieved by including an efficient noise



suppression software. On the large 2.2" color TFT screen, a graphical user interface provides easy access to all functions including contacts and settings. The user interface also provides direct access to certain features of a connected BGAN terminal.

When used with a BGAN terminal and a SAILOR 3771 Alarm Panel, the IP Handset can be used as a designated handset for Voice Distress and urgency calls.

The IP Handset

The IP Handset is powered directly from the LAN interface using Power over Ethernet (PoE), so an external power supply is not needed.

The TT-3670A Thrane IP Handset & Cradle, wired, includes the following main units:

- TT-3672A Thrane IP Handset, wired
- TT-3674A Thrane IP cradle, wired

The IP Handset connects to the cradle with a coil cord. The cradle connects with a fixed LAN cable to a LAN port with PoE, for example in a BGAN terminal (Broadband Global Area Network) for satellite communication.

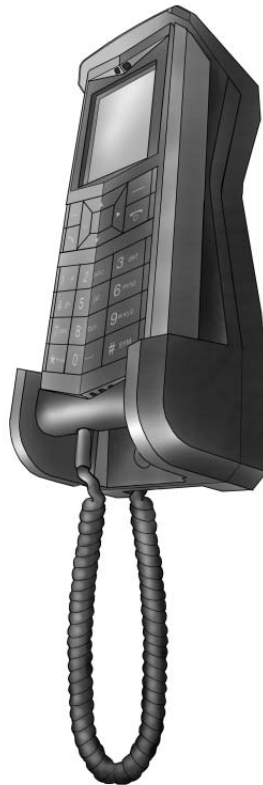

Features

The IP Handset offers the following features:

- Plain voice communication over Internet or IP based network
- Start and stop IP data connections in a connected BGAN terminal
- Contacts list with up to 100 entries
- Intuitive user interface and menu system
- Built-in web server
- High quality color display QVGA with night colors
- Rugged but elegant design
- Splash proof and dust proof
- Connectivity to Broadband Global Area Network (BGAN) terminal
- BGAN menu to display BGAN terminal type, GPS position and more
- Display of critical alarms from the BGAN terminal
- Use as Distress IP Handset together with BGAN terminal and SAILOR 3771 Alarm Panel

Get started

This chapter describes how to install and start up the IP Handset and make the first call. It also gives an overview of the display and keypad and explains how to navigate with the keypad.

Get started with the IP Handset

Introduction

The IP Handset connects to the cradle with a coil cord. The cradle connects with a fixed LAN cable to a LAN port with PoE, for example in a BGAN terminal. The IP Handset is powered directly from the LAN (PoE) interface.



Connectors on the handset

IP Handset connectors

The IP Handset has a coil cord with a LAN connector for connecting to the cradle or directly to a LAN (PoE) interface.

The handset also has two connectors on the side of the handset:

- one connector for connecting a headset (3.5 mm SMT phone jack, Switchcraft 35RASMT3BHNTR).
- one Mini-USB connector (not in use).

IP cradle connectors

The cradle for the IP handset has two internal LAN connectors and an alternative terminal block for the LAN connection:

- One LAN connector connects to the coil cord from the IP Handset.
- The other LAN connector, or alternatively the terminal block, connects to your LAN cable between the cradle and the BGAN terminal.

Connect the cables to the IP cradle

To connect the cables to the IP cradle, do as follows:

1. Remove the two screws holding the centre cover in the bottom of the cradle and take off the cover.

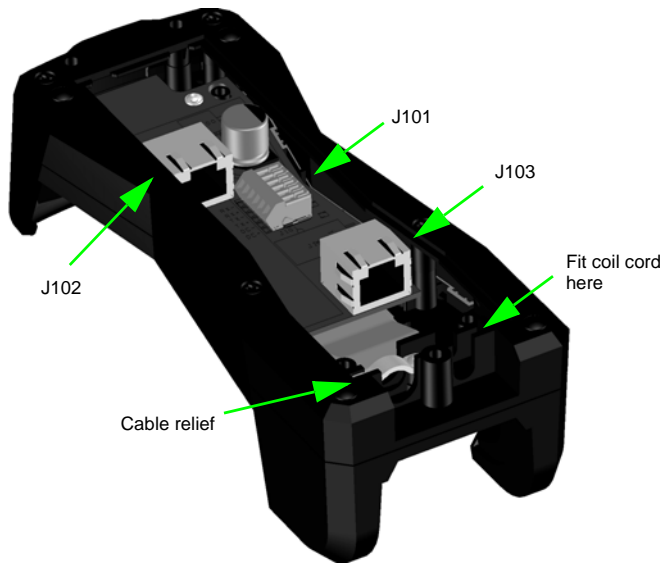

2. Connect the coil cord from the IP Handset to the cradle connector marked J103. Then fit the cable relief mounted on the coil cord into the groove at the cradle exit.
3. To mount the external LAN cable, do one of the following:
 - Connect a standard LAN cable to the connector marked J102 in the cradle. This is the cable for connecting to the BGAN terminal or other LAN (PoE) interface.

Important

The space between the cable LAN connector and the PCB is very scarce - make sure the housing of the cable connector is not too thick to allow for the connectors to fit properly.

- Connect the wires of a LAN cable to the terminal block marked J101. The text next to the terminal block indicates which signal goes where.
4. Mount cable relief at the cable exit from the cradle.

Note

Make sure the cable relief matches the size of the cable.

5. Mount the cover and fasten the two screws.

Install the cradle

Mount the cradle on a wall or a desktop with 3 screws fitting in the holes indicated in the drawing below (front view).

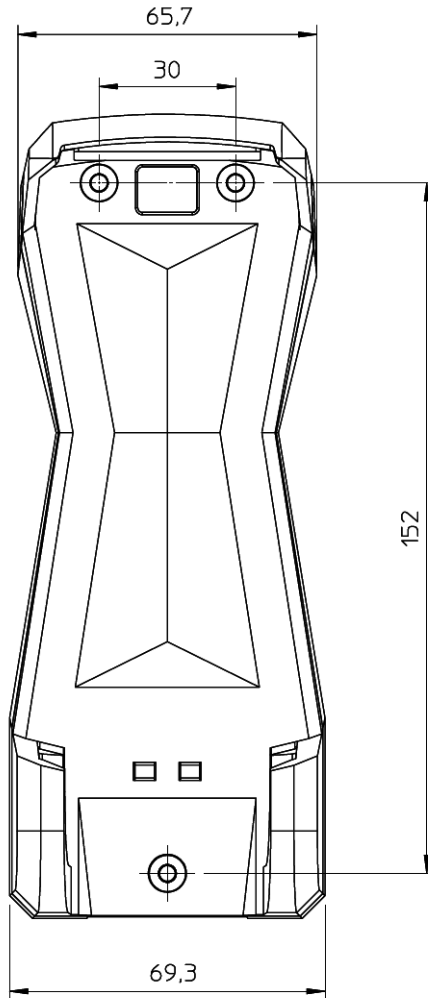

Connect the IP Handset to a BGAN terminal

Note

The LAN interface on the BGAN terminal must supply Power over Ethernet.

To connect the IP Handset to a BGAN terminal do as follows:

1. Start up the BGAN terminal as described in the user manual for the terminal.
2. Connect the LAN cable from the IP cradle to one of the LAN (PoE) connectors on the BGAN terminal.

The cable between cradle and terminal must be maximum 80 m.

Note

If you insert a switch or similar between the cradle and the terminal, make sure that it conforms to the industry PoE standard **IEEE 802.3 af (using data pairs)**.

The IP Handset starts up automatically when connected to the BGAN terminal. However, you may have to configure user name and password if the handset has not been connected before, and if it is not set up to automatically connect with the SIP server of the terminal. For further information, see *Establish a connection using BGAN terminal* on page 11.

Start up the IP Handset

To switch on the IP Handset

The IP Handset is automatically powered when it is connected to a LAN interface with PoE.

If the handset has been switched off, you can switch it back on by pressing and holding the on hook key until the display lights up.



If the handset does not start up, the reason may be that there is no PoE in the LAN interface. If you are connecting to a BGAN terminal, check that the PoE indicator on the terminal lights green for the connected port. For further information, refer to the installation manual for the BGAN terminal.

To switch off the IP Handset, press and hold the on hook key again until the display is turned off.

Establish a connection using BGAN terminal

To use a BGAN terminal

Introduction

By connecting the IP Handset to a BGAN terminal you gain access to the BGAN satellite network with your IP Handset.

When connected with the BGAN terminal the IP Handset provides a dedicated menu for the terminal.

IP Handset connection

The IP Handset is connected to the BGAN terminal by connecting the Ethernet cable from the cradle to one of the LAN ports of the terminal. For further information, see *Connect the IP Handset to a BGAN terminal* on page 9.

To establish a connection

When the handset is connected to the BGAN terminal, it is automatically registered in the terminal and assigned the first available local number, if the startup option **Auto BGAN SIP** is selected under **Settings > Startup options** in the handset menu (selected by default). If, for some reason, you need another password or local number, you need to set up the following in the handset and in the web interface of the BGAN terminal (the startup option **Auto BGAN SIP** must be disabled!):

- User name
- Password
- Local number

For further information, see *Change user name and password for an IP Handset* on page 14.

If no SIM PIN is required

If the IP Handset is connected to a BGAN terminal where the SIM PIN is disabled or has already been entered, the BGAN terminal automatically sets up a communication profile (SIP profile) and assigns the first available local number to the handset, if the startup option **Auto BGAN SIP** is enabled under **Settings > Startup options** in the handset menu.

If a SIM PIN is required

Note

There may be 2 PIN codes for the system:

- one for the BGAN terminal (SIM PIN, described in this section) and
- one for the IP Handset (described in *To set up the PIN code for the handset* on page 59)

If the IP Handset is connected to a BGAN terminal where the SIM PIN is required and has not yet been entered, you need to enter the SIM PIN for the terminal. To do so, you need to know the Administrator user name and password as well as the SIM PIN for the BGAN terminal.

To enter the BGAN terminal's SIM PIN, do as follows:

1. From the main screen of the handset, press the center select key to enter the menu system.
2. Select **BGAN**.
3. Select **Enter PIN code**.

Note

This menu item is not available if the PIN has already been accepted. You can check at **Status > PIN status** to see if the PIN has been accepted.

4. Enter the Administrator user name and select **OK**.
For information on how to type text in the handset, see *How to enter text in the IP Handset* on page 42.
5. Enter the Administrator password and select **OK**.
6. Enter the SIM PIN and select **OK**.
If the SIM PIN is rejected, see the next section *Wrong PIN*.

When the PIN is accepted, the BGAN terminal automatically sets up a SIP profile and assigns the first available local number to the handset, if the startup option **Auto BGAN SIP** is enabled under **Settings > Startup options** in the handset menu.

Wrong PIN

After entering the user name and password, you have 3 attempts to enter the PIN, before you are asked to enter the PUK (Pin Unblocking Key). The PUK is supplied with your BGAN SIM card.

Enter the PUK followed by a new PIN of your own choice. The PIN must be from 4 to 8 digits long.



Caution! If you enter a wrong PUK 10 times, the SIM card will no longer be functional, and you have to contact your Airtime Provider for a new SIM card.

IP Handset ready

When the display shows the handset ready symbol  in the upper right corner, the handset is ready for making a call.

If the handset ready symbol is crossed out  you cannot make a call. The display will normally show a message explaining why the handset is not ready.

Change user name and password for an IP Handset

By default, the startup option **Auto BGAN SIP** is selected under **Settings > Startup options** in the handset menu. This means that an IP Handset that is connected to the terminal automatically gets the first available user name (local number) and password. If you want to change the user name or password, you need to set up the user name, password and local number in two places:

- In the IP Handset
- In the web interface of the BGAN terminal.

To enter user name and password in the IP Handset

Note Make sure you have disabled **Auto BGAN SIP** under **Settings > Startup options**. Otherwise the information entered below is not used at next startup!

To enter the user name and password in the IP Handset, do as follows:

1. Start up the handset as described in the previous sections.
2. Enter the menu system and select **SIP**.
3. Move to the **BGAN** profile and select **Options** (left select key).
4. Select **Edit/View**.
5. Select **User name** and enter the user name for your handset. Note that the user name must be the same as the local number for your handset when using the BGAN terminal. Available numbers are 0501 to 0516.
6. Select **Password** and enter the password for your handset. Note this password for later use in the terminal. You can use the local number as the password as well, i.e. 0501 to 0516.

Note The IP Handset only supports numbers (no letters) in the password.

7. Exit the menu.

To enter user name and password in the BGAN terminal

To match the IP Handset with the BGAN terminal you must enter the local number and password for each IP Handset in the web interface of the BGAN terminal.



To set up the BGAN terminal, do as follows:

1. Connect a computer to the LAN interface of the BGAN terminal and start up your browser.
2. In the address bar, enter **ut.bgan** or the IP address for the BGAN terminal. The default IP address is 192.168.0.1.
The web interface opens.
3. Select **SETTINGS > IP handsets**.
4. Locate the local number that matches the user name (local number) of your handset and click **Edit**.
5. Enter the same password you entered in the handset.

When the terminal and the handset have recognized each other, a **Configure** link appears next to the new handset in the web interface of the terminal. Click the **Configure** link to open the internal web server of the IP Handset. For information on the web server, see *To use the web server* on page 75.

Make the first call

To make a call, do as follows:

1. Type the phone number on the keypad.
If the number is in the Contacts list of the handset, you can also select the number from there.
2. Press the off hook key in the left side of the keypad  or press #.
The display shows that the number is being dialled.
3. **Volume up or down:** If you need to adjust the voice volume during a call and the display shows the main screen, press  or  on the keypad.

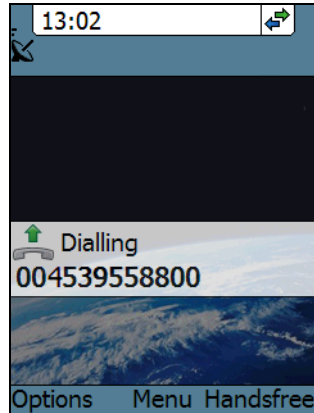

For further information on how to make calls, see *Handle calls* on page 30.

IP Handset keypad and display

The keypad



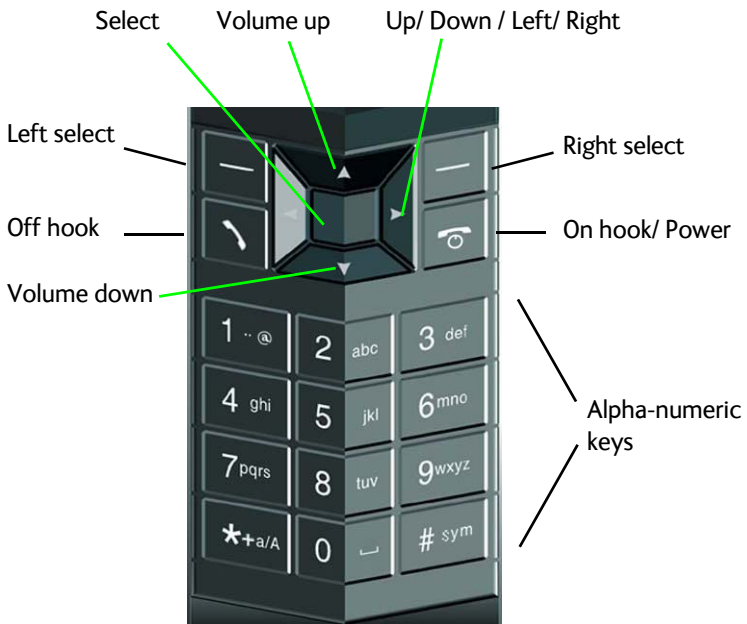

The following drawing shows the keypad of the handset.



The next sections explain the functions of each key in the keypad.

Control keys

The below table shows the functions of the control keys in the upper section of the keypad.

Key	Functions
	Left select. Selects the function shown in the display just above the key (left soft key).
	Right select. Selects the function shown in the display just above the key (right soft key). From main screen: Opens the Contacts list.
	Off hook. After entering a phone number: Initiates a call to the number. From main screen: Opens a list of the latest calls, including incoming, outgoing and missed calls.
	On hook/ Power. When the handset is ringing: Rejects the call. During a call: Ends the call. When in the menu system: Abandons the menu system and displays the main screen. Otherwise: Powers the handset on/off, when pressed and held for 3 seconds. If there is an error and the handset does not power off after approximately 3 seconds, hold the key for 10 seconds, and the handset will perform a hardware reset.

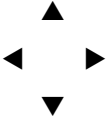
Key	Functions
	<p>Select (center).</p> <p>Selects/confirms the function highlighted in the display.</p>
	<p>Navigation.</p> <p>Navigates through the menu system in the display.</p> <p>Right/Left are also used to change settings in the menus.</p> <p>From main screen: ▲ Volume up, ▼ down</p> <p>See also <i>Keypad shortcuts</i> on page 22.</p>

Alpha-numeric keys

This section shows the functions of the alpha-numeric keys in the lower section of the keypad.

The functions available depend on whether you are typing a phone number (number mode) or text (text mode).

In number mode, you get the number of the key pressed. Only * has two functions.



Press * once: The display shows *.

Press * twice, or press and hold: The display shows +.

Press #: The display shows #.

In text mode, you have the functions listed below.

The * key switches between text and number mode. There are three options: Numeric, lowercase and uppercase characters. You can see in the lower left corner of the display which mode is currently selected.

To get numbers from lowercase or uppercase mode, press and hold the key.

At numerous presses on the same key, the character changes in the same sequence that the characters are listed in the following table.

Key	Numeric output	Lowercase output	Uppercase output
1	1	. , @ : - ?	. , @ : - ?
2	2	a b c	A B C
3	3	d e f	D E F
4	4	g h i	G H I
5	5	j k l	J K L

Key	Numeric output	Lowercase output	Uppercase output
6	6	m n o	M N O
7	7	p q r s	P Q R S
8	8	t u v	T U V
9	9	w x y z	W X Y Z
0	0	[space]	[space]
*	Switches between lowercase, uppercase and numbers		
#	Symbols. Displays a list with the following additional symbols: . / : @ \$ % ^ & * () ~ ' - _ = + [] { } \ ; ´ " ! < > , ? # € <CR>		

To navigate with the keypad

To enter the menu system from the main screen, press the center select key.

To move through the menus, press the navigation keys (arrows).





To select a highlighted menu item, press the center select key.

To select one of the items in the action texts area, press the key just below the text you want to select.

To go back one level in the current menu, press the right select key (only when **Back** is displayed above the key).

Keypad shortcuts

The following shortcuts are available:

	When the display is in the main screen, this key gives direct access to the list of contacts.
	When the display is in the main screen, this key opens a list of the latest incoming, outgoing and missed calls.
	When the display is in the menu system, the on hook key will exit the menu system and show the main screen.
	When the display is in the main screen, the right select key will open the list of contacts. From inside the Contacts list, press the first letter of an entry to access the entry in the Contacts list.
Alpha-numeric keys	When the display is in the menu system, an alpha-numeric key will jump to the menu item with the pressed number or, in the Contacts list, to the first entry beginning with the pressed letter.

The display

The display of the IP Handset is divided into sections with different types of information. The sections are outlined below.

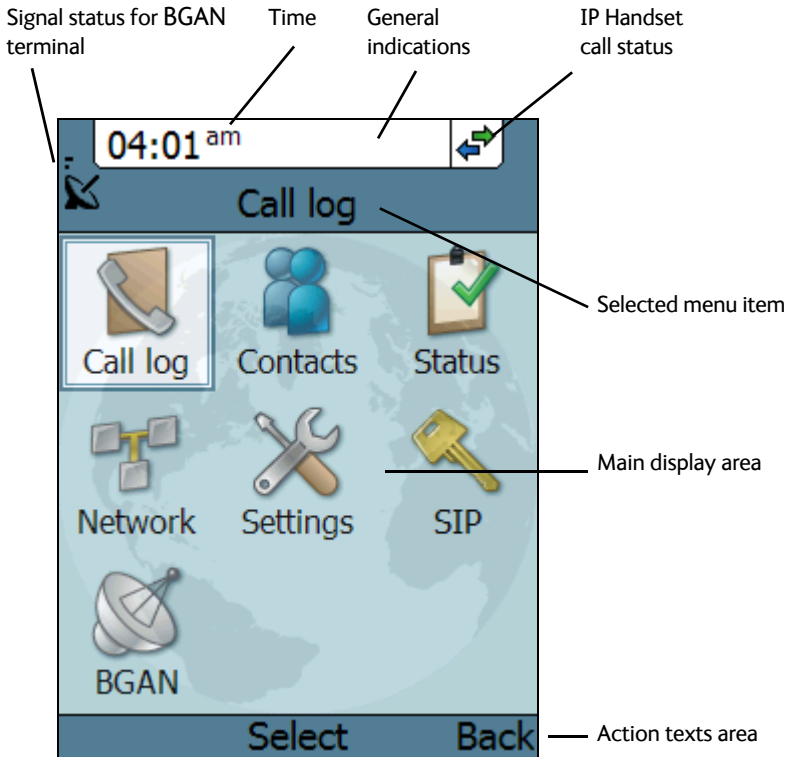

BGAN signal status

When the IP Handset is connected to a BGAN terminal, the display shows the signal strength of the BGAN signal.

Time

The display shows the time of day.

The format is selectable in the **Settings > Date and time** menu.

General indications

General indications are icons that show dynamic information such as missed calls, sounds off, keypad locked and microphone muted.

For explanations of the icons, see *Icons in the display* on page 25.

IP Handset call status

This field shows handset status such as whether or not the handset is ready for making calls, or whether there is an ongoing call.

For explanations of the icons, see *Icons in the display* on page 25.

Main display area











The main display area primarily displays the menus and messages to the user.









Action texts area

The action texts are used to indicate an action that takes place when the corresponding key is pressed. The corresponding key is the key directly below the text (left select, center select or right select).

Icons in the display

The below table explains the icons in your display.

Icon	Meaning
	BGAN terminal connected (used together with signal strength).
	Signal strength for BGAN terminal.
	The handset is ready for making calls.
	The handset is not ready for making calls.
	Active alarm in BGAN terminal.
	The handset is designated for Voice Distress (when used with a Voice Distress system)
	Incoming call - not yet answered (the handset is ringing).
	Incoming call in progress.
	Outgoing call - not yet answered.
	Outgoing call in progress.

Icon	Meaning
	Call ended.
	Missed call. See the Call log for information on the call.
	The microphone is muted. To reactivate the microphone, select Options (left select key) > Microphone.
	The handset is in silent mode. All external sounds from the handset - including ring tones - are muted. Voice is not muted.
	This symbol is shown when you are adjusting the volume.
	The keypad is locked. To unlock the keypad, press the center select key followed by the left select key.
	This symbol is used in the Contacts list to indicate that the number is from the phone book of the BGAN terminal and is read-only.
	When an alpha-numeric key is pressed from inside the Contacts list, this symbol is shown while the handset is searching for entries with the letter pressed.
	Wait - a task is in progress.

Screensaver

You can choose to have a screensaver activated when the handset is not used for one minute. This screen shows only the time, handset status and general indications such as missed calls.

When you press a key the display returns to the normal display function.

To enable or disable the screensaver, enter the menu system, select **Settings > Display** and select **Screensaver**. When the box is checked, the screensaver is enabled.

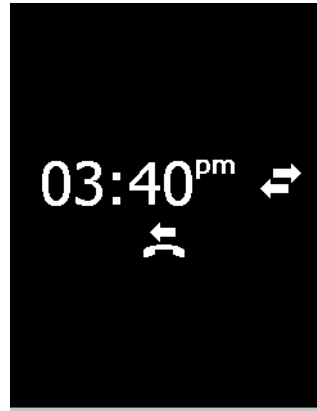

Note

If you have a PIN code for your handset, you must enter the PIN code to gain access to the handset when the screensaver is on.

To use the IP Handset

This chapter describes how to use the IP Handset. It also describes how to configure the handset and use the display menu system, including a short description of how to use the IP Handset with a BGAN terminal.

For information on how to connect and start up the handset, and how to navigate with the keypad, refer to the previous chapter, *Get started*.

User interfaces



The main user interface for the handset is the display menu system. However, with a computer and a browser you can also use the built-in web server to access a subset of the handset settings. This way you can take advantage of a larger screen and still access a subset of the handset settings.

- **The display menu system** is described in *IP Handset menus* on page 44.
For an overview of the keys and display, and explanation of keys and display symbols, see *IP Handset keypad and display* on page 17.
- **The web server** is described in *To use the web server* on page 75.

IP Handset functions

Handle calls

Handset ready

When the status field for the IP Handset shows ready  , you can make or receive calls.

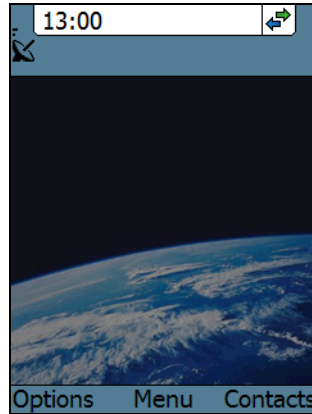

To make a call

To make a call, simply type the phone number and press  or #.



Note

If the handset is in the cradle while you make the call, the mode will automatically be hands-free (default function). For further information, see *To set up the function of the cradle* on page 54.

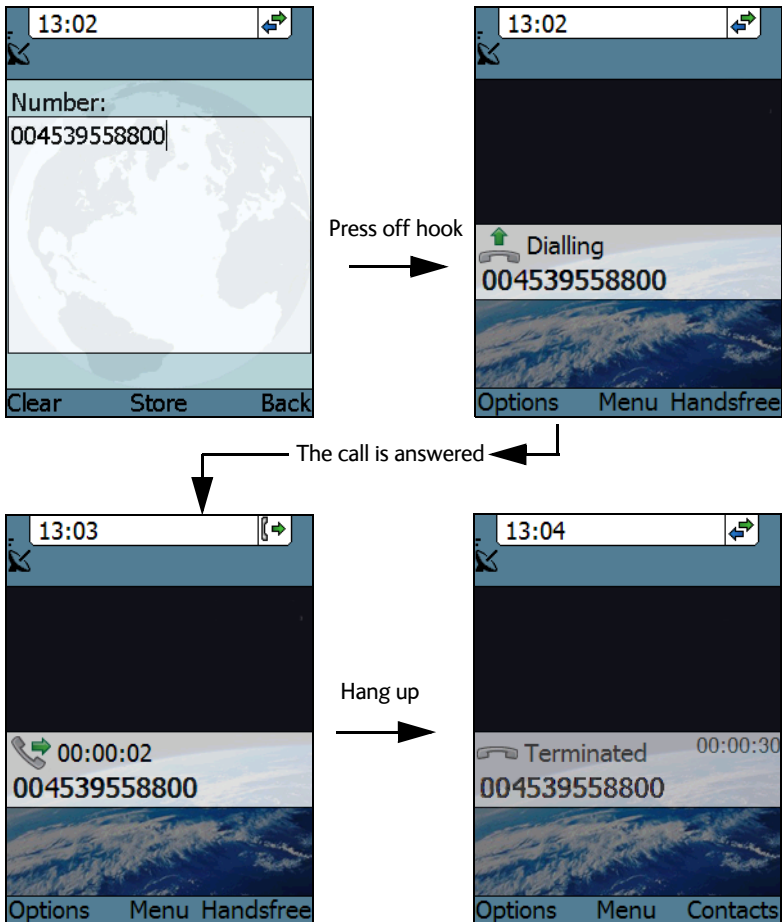
The display shows the progress as follows:



You can also call a number from your contacts or from a list of recent calls:

- **Contacts:** Press the right select key from the main screen and move to the contact you want to call. Then press the off hook key.
- **Recent calls:** To see the latest calls (incoming, outgoing and missed calls), press  from the main screen. Press  again to call the selected number.

For information on how to make calls using a BGAN terminal, see *Make a call using a BGAN terminal* on page 38.

To receive a call

When the handset is ringing, the display shows the calling name or number, if known.

Answer the call by pressing the off hook key in the left side of the keypad , or by removing the handset from the cradle. For information on cradle detection, see *To set up the function of the cradle* on page 54.

Note If the handset is in the cradle while you answer the call, the mode will automatically be hands-free (by default).

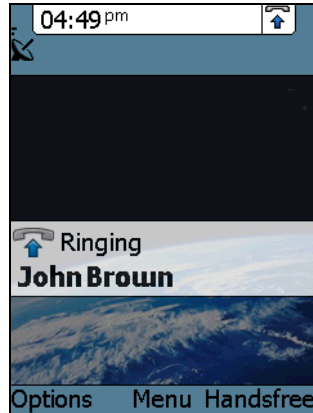

Any open menus are closed down when the handset is ringing.

You can see unanswered calls under **Call log** in the IP Handset menus or in the web server.

To transfer a call

When you receive a call, you can transfer it to another phone connected to the terminal. The most commonly used scenario is that you make a blind transfer. This means that you transfer the call directly to a new number, without talking to the new number before putting the call through.



To transfer a call, do as follows:

1. Having taken the call, you press **Options**.

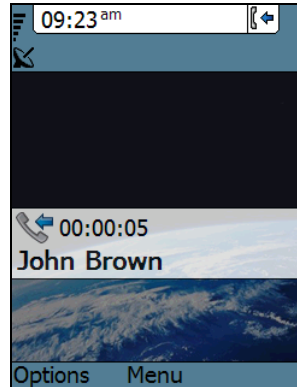

2. Scroll to **Transfer <number to transfer>** and press **Select**.

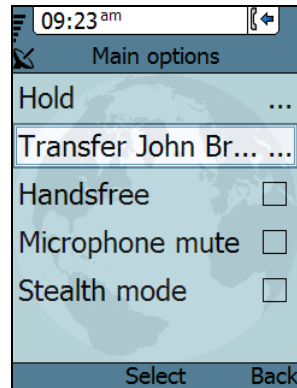

3. If the local numbers are entered in the phone book, the display shows the local numbers available for transferring the call.

In the example you can transfer the call to one of the local phones Local 0301 or Local 0503.

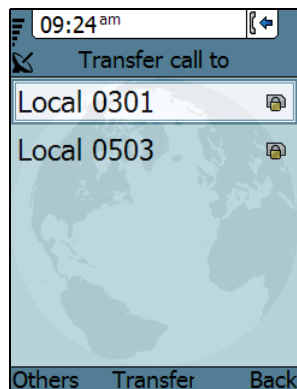

- If there are no entries for local phones in the phone book, select **Enter number** and press **Select**.
In the example the call is transferred to the local phone 0503.

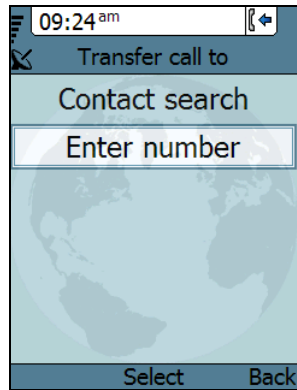

- Enter the local number, in this case **0503**, and press **Transfer**. The BGAN terminal makes sure that the call is transferred properly to the new local number.
The phone with the local number you dialed starts to ring.

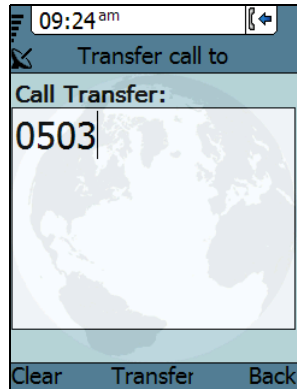

- The incoming call is handed over to 0503.
When the call is taken, it is established between the initial caller and the new recipient.

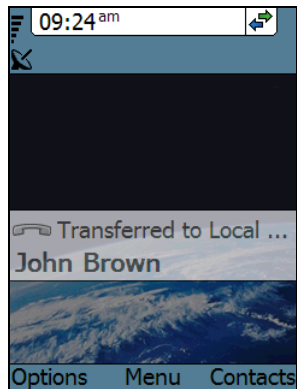

To transfer a call with announcement

When transferring a call, you can put the current call on hold, call the new number and announce the call to be transferred, terminate the announcement call and then transfer the original call.

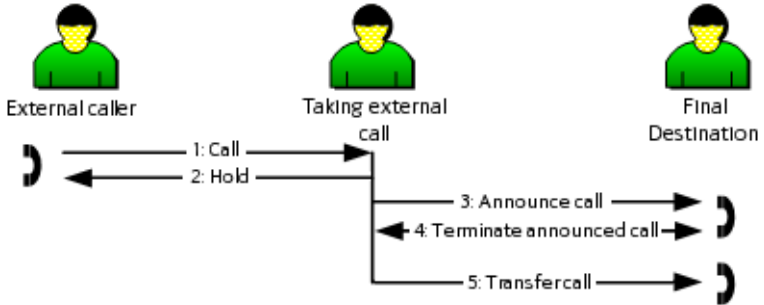

To transfer a call with announcement, do as follows:

1. Having taken the call, you press **Options**.

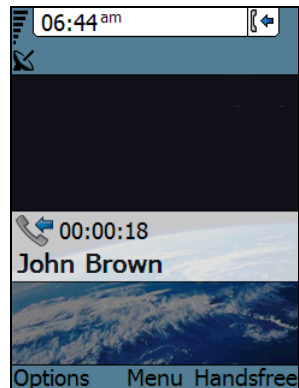

2. Select **Hold**.

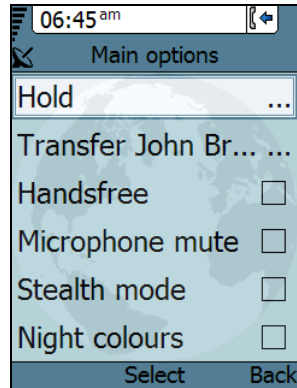

3. The incoming call is put on hold.
4. Select **Enter number** to enter the local number you want to transfer the call to or select **Contact search** to select a number from the **Contacts** list.

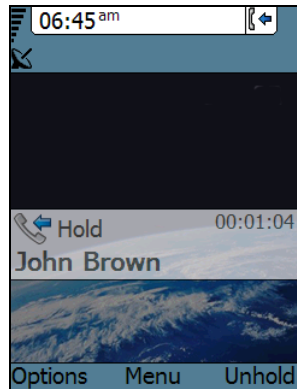

5. In this example the original call is transferred to the local phone 0503. The phone with the local number you dialed starts to ring.

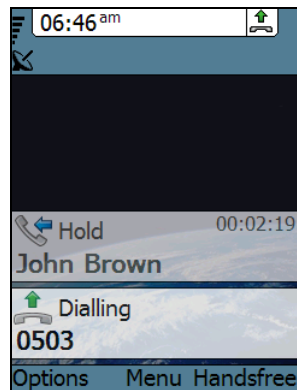

6. When 0503 picks up the call you can announce the original call that is on hold.

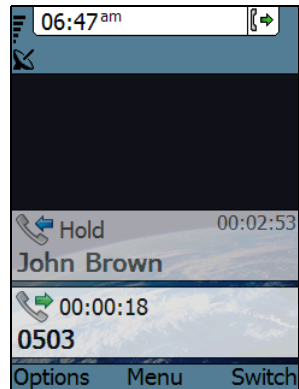

7. To be able to transfer the original call that is on hold, the announcement call to the local number must be terminated, either by you or the final recipient. This is to free the line for the original call.

Press the **on-hook key**  to terminate the announcement call, in this example the call to 0503.

In case you need to talk to the original caller again, press **Switch**.

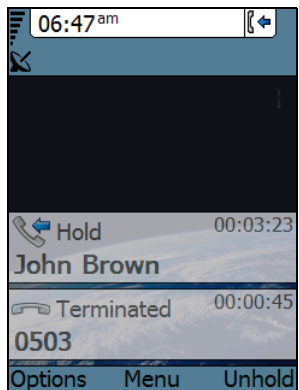

8. If you wish to talk to the original caller again before transferring the call, select **Unhold**.

Select **Transfer** to transfer the original caller.

Proceed as described in *To transfer a call* on page 32.

Note | The BGAN system only supports one external call at a time.

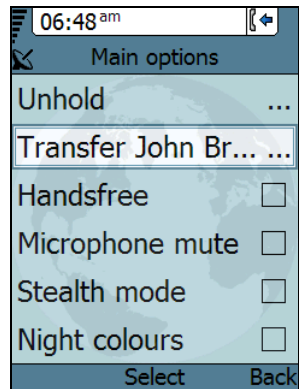

To end or reject a call

Press the on hook key  to end an ongoing call or to reject an incoming call.

When the handset is in hand-held mode, you can also end the call by placing the handset in the cradle.

Make a call using a BGAN terminal

When making a call with the IP Handset using a BGAN terminal you use the BGAN network and its functionality.

To make a call from a handset connected to a BGAN terminal

To make a call from a phone or handset connected to a BGAN terminal, dial

00 <country code> <phone number> followed by  or #.

Example: To call the number +45 39558800,
dial **00 45 39558800** followed by  or #.

Note

The default call type is set up in the web interface of the BGAN terminal. However, you can select the call type for your call, using a prefix.

Dial **1 *** before the number to make a Standard Voice call.

Dial **2 *** before the number to make a 3.1 kHz Audio call.

Example: Dial **2 * 004539558800** to make a 3.1 kHz Audio call to the number +45 39558800.

To make a call to a handset connected to a BGAN terminal

Note

By default all handsets connected to the terminal will ring on incoming calls.

To make a call to a handset connected to the BGAN terminal, dial

+870 <Mobile number>

- + is the prefix used in front of the country code for international calls. This is **00** when calling from most countries.
- **Mobile number:** The mobile number of the BGAN terminal you are calling.

Example: If you are calling from Denmark and the mobile number for 3.1 kHz Audio is 772112345 on your BGAN terminal, and you want to make a call to the BGAN terminal using 3.1 kHz Audio, dial **00 870 772112345**.

To see the mobile numbers of your BGAN terminal, refer to the information included with your airtime subscription.

Note

There are two Voice numbers, one for Standard Voice and one for 3.1 kHz Audio.

For more information on call types and the BGAN terminal, refer to the user manual for your BGAN terminal.

Use the IP Handset for Voice Distress

When used with a BGAN terminal, the IP Handset can be used to make Distress calls initiated by the SAILOR 3771 Alarm Panel. For instructions how to configure the IP Handset for Voice Distress see the *Voice Distress (Non-SOLAS) User manual*.

Quick settings

To control the volume in the earpiece

To adjust the voice volume during a call (with the display in the main screen), press ▲ or ▼ on the keypad.

To use hands-free operation

To enable hands-free operation during a call, use the right select key to select **Handsfree**. To go back to hand-held mode, press the right select key again.

In hands-free mode the sound is routed to a speaker, so that you can use the phone without holding it close to the ear. You can adjust the volume with ▲ or ▼ as described in the previous section.

Handset in cradle:

You can also make a hands-free call by leaving the handset in the cradle while making the call. Similarly you can answer a call using hands-free mode by leaving the handset in the cradle while answering the call.

In both cases, the default function is as follows:

- If you remove the handset from the cradle during the call, the mode will automatically change to hand-held.
- When the handset is out of the cradle in **hand-held** mode, the call will be terminated when you put the handset back in the cradle.
- When the handset is out of the cradle in **hands-free** mode, you can put it back in the cradle without terminating the call.

Note

You can change this default function under **Settings > Cradle**, if you want the handset to be independent of the cradle. For further information, see *To set up the function of the cradle* on page 54.

To mute the microphone

You can mute the microphone of the IP Handset. To mute the microphone during a call, do as follows:

1. Select the left **Options** menu.
2. Select **Microphone mute**.

To lock the keypad

You can lock the keypad of the IP Handset. When the keypad is locked you can still answer incoming calls. To lock the keypad, do as follows:

1. Select the left **Options** menu.
2. Select **Keypad lock**.

To unlock the keypad, do as follows:

1. Press the center select key.
2. Press the left select key.

To use night mode

The display has a night mode for operation in low light areas. In night mode, the colors are changed to make the display more suitable for night operation. The IP Handset can be set to automatically switch between day and night mode.

If the automatic switch between day and night mode is not selected, you can activate the night mode manually.

To activate night mode, do as follows:

1. Select the left **Options** menu.
2. Select **Night mode**.

To set the IP Handset to automatic switch between day and night mode see *To set up the display* on page 55.

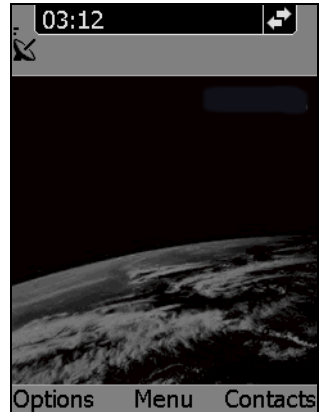

To use stealth mode

Stealth mode is used when the IP Handset should not be noticed. In stealth mode you can turn off all lights in the display and/or sounds for external events. Note, however, that the keypad will still light up when you press a key.

To activate stealth mode, do as follows:

1. Select the left **Options** menu.
2. Select **Stealth mode**.

Note

Stealth mode is only activated for the items you have selected in the menu **Settings, Stealth**. See *To set up stealth mode* on page 52.

How to enter text in the IP Handset

When entering your contacts in the IP Handset you use the keypad to enter the names.

Press * before the alpha-numeric key to switch between lower case, upper case and numbers.

There are 3 or 4 letters on each key. To obtain the next letter on the key, press the key again.

To move the cursor in the text, use the arrow keys.

To delete the letter just before the cursor, press the left select key **Clear**. Hold the key to delete all the text.

For a list of the key-functions in text-mode, see the table on page 20.

Example

To type “He”, do as follows:

1. Press * one or two times until the lower left corner of the display shows upper case letters.
2. Press the key **4 ghi** two times to display the letter **H**.
3. Press * again until the lower left corner of the display shows lower case letters.
4. Press the key **3 def** two times to display the letter **e**.

To use a headset

You can connect a headset to the IP Handset as follows:

Plug the headset jack into the jack connector on the side of the handset.

Note

Use a headset with the connector type: 3.5 mm SMT phone jack, Switchcraft 35RASMT3BHNTR. Other headset types may not work with the IP Handset.

The microphone and speaker of the IP Handset are automatically disabled and the headset is used instead.

IP Handset menus

The menu system gives you access to the user parameters of the IP Handset. To access the menu system from the main screen, press the center select key. Move around in the menus with the arrow keys and select with the select keys. Leave the menu system by pressing the on hook key.

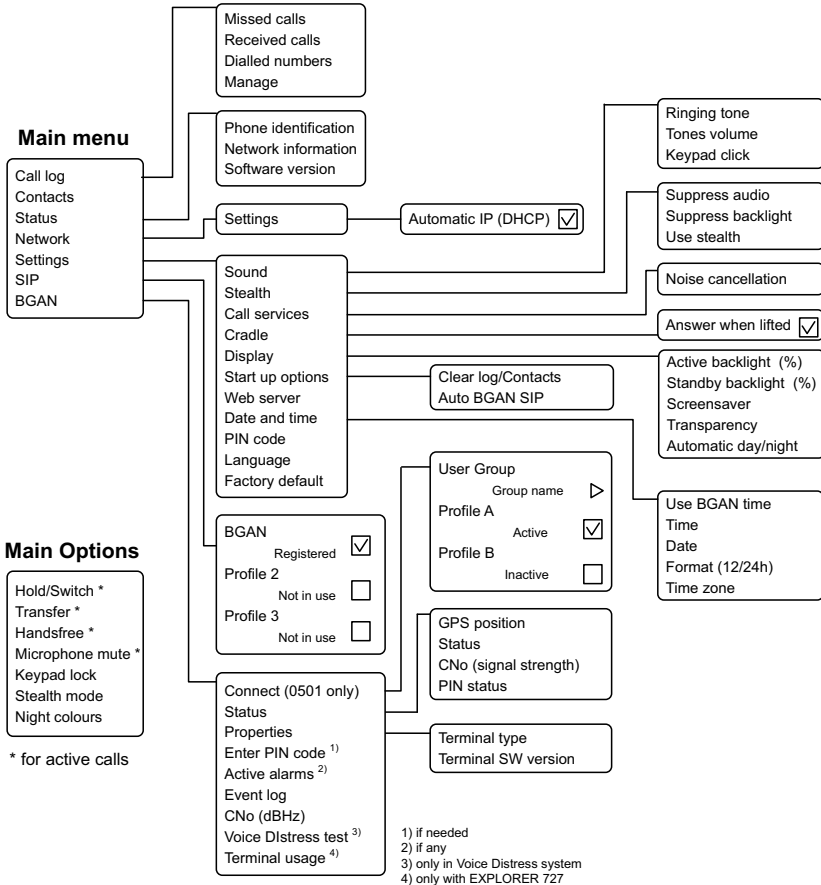

Call log

The IP Handset logs all calls and dialled numbers. The log entry shows the name (if known), the number, time of the call and duration. Note that the call log can hold maximum 100 calls. You can delete calls from the call log.

To display the call log

To display the call log do as follows:

1. From the main menu, select **Call log**.
2. Select the list you want to see.
3. If you want to see details for a call, move to the call and select **View**.

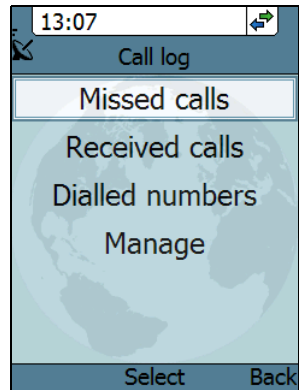

To add a number from the call log to the Contacts

To add a number from the call log to the Contacts do as follows:

1. In the call log, go to the call and select **Options**.
2. Select **Add to contacts**.
Note that the Contacts list can hold maximum 100 entries.
3. Type in the name of your new contact and select **OK**.

To delete a number from the call log

To delete a number from the call log do as follows:

1. In the call log, go to the call and select **Options**.
2. Select **Delete**.
3. Select **Yes**.

To delete all numbers in a call log folder

To delete all numbers in the call log, or all numbers in a sub-folder of the call log, do as follows:

1. In the call log menu (not in one of the sub-folders) select **Manage**.
2. Select the folder you want to empty.
3. Select **Yes**.

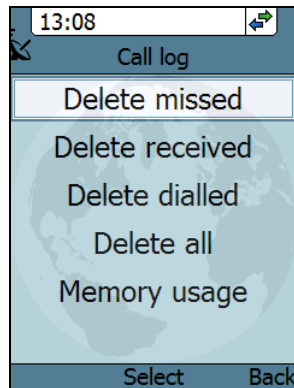

To see memory usage in the call log

To see the number of stored entries and the maximum allowed number of entries, do as follows:

1. In the call log menu (not in one of the subfolders) select **Manage**.
2. Select **Memory usage**.

Contacts

Use the contact list of the IP Handset to find a contact and make a call or manage your contacts. You have access to the contacts in the BGAN phone book.

To display your contacts

To display your contacts, do one of the following:

- From the main screen, press the right select key,
- from the main screen, press ▼, or
- from the main menu, select **Contacts**.

If a contact is from the BGAN phone book it is marked with . This means you cannot edit or delete the entry.

To call a contact

To call a contact, do as follows:

1. In your Contacts list, scroll to the contact you want to call.
2. Press the off hook key.

To add a contact

To add a contact, do as follows:

1. In your Contacts list, press the left select key, **Options**.
2. Select **Add**. Note that the Contacts list can hold maximum 100 entries.
3. Type in the name of your contact and select **OK**.
The name can be maximum 32 characters. For information on how to enter text, see *How to enter text in the IP Handset* on page 42.
4. Scroll to **Number** and select **Edit**.
5. Type in the number of your contact and select **OK**.
The number can be maximum 32 characters.

To edit a contact

To edit a contact, do as follows:

1. In your Contacts list, scroll to the contact you want to edit.
2. Press the left select key, **Options**.
3. Select **View/Edit**.
4. Select **Edit**.
5. Change the name of your contact and select **OK**.
For information on how to enter text, see *How to enter text in the IP Handset* on page 42.
6. Scroll to **Number** and select **Edit**.
7. Change the number of your contact and select **OK**.

To delete a contact

To delete a contact, do as follows:

1. In your Contacts list, scroll to the contact you want to delete.
2. Press the left select key, **Options**.
3. Select **Delete**.
4. Press the left select key, **Yes**.

The contact is now deleted from your Contacts list.

Status

In the Status section you find the serial number of the IP Handset, the network settings and the software version of the IP Handset.

To view status for the handset, do as follows:

1. From the main menu, select **Status**.
2. Select **Phone identification** to see the serial number of the IP Handset.
3. Select **Network information** to see:
 - DHCP Enabled/Disabled
 - IP address
 - Subnet mask address
 - Default gateway
 - Physical address (MAC)
4. Select **Software version** to see the version of the IP Handset software.

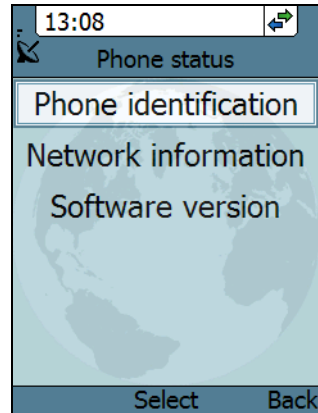

Network

To select the IP address mode

You can select whether or not the IP Handset should use DHCP to automatically obtain an IP address. Static IP addresses are also supported. It is recommended to use DHCP. Automatic IP (DHCP) is the default setting.

To select the IP mode, do as follows:

1. From the main menu, select **Network**.
2. Select **Settings**.
3. Do one of the following:
 - If the IP Handset should use DHCP to automatically obtain an IP address, check the box next to **Automatic IP (DHCP)** and select **Back** or press the on hook key to exit completely.
 - For a static IP address, clear the box next to **Automatic IP (DHCP)**. Then select **Yes** to confirm and continue to the next step.
4. If you selected not to use DHCP, scroll down to **IP address**.
5. Click **Edit**, type in the IP address and select **OK**.
6. Continue to **Subnet mask**, **Gateway**, **Primary DNS** and **Secondary DNS** and enter them in the same way.
7. Select **Back** or press on hook to exit. The handset will now use the static information you entered, instead of automatic IP address allocation using DHCP.

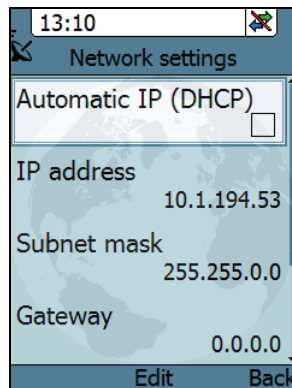
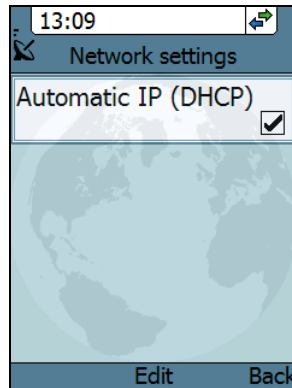

Settings

To access the Settings menu, select **Settings** from the main menu.

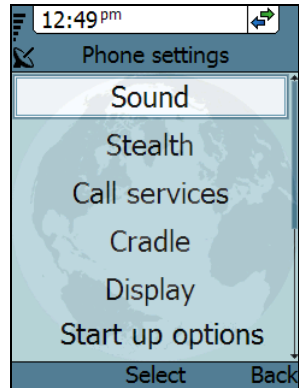

To adjust the sound

You can adjust the ringing tone, the tone volume and the keypad click.

To adjust the sounds of the handset, do as follows:

1. From the **Settings** menu, select **Sound**.
2. Use the arrow keys to move to the sound you want to adjust.
3. For **Keypad click**, select **Edit** to change the setting.
4. For the other settings, use the keys ◀ and ▶ to change the setting, or select **Edit**, select the setting you want and select **OK**.

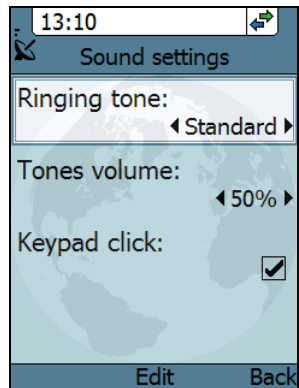

To set up stealth mode

Stealth mode is used when the IP Handset should not be noticed. In stealth mode you can turn off all lights in the display and/or sounds for external events. Note, however, that the keypad will still light up when you press a key.

To configure and go into stealth mode, do as follows:

1. From the **Settings** menu, select **Stealth**.
2. Move to **Suppress audio** and/or **Suppress backlight** and select **Edit** to change the setting.

Note

These settings are only activated when **Use stealth** is checked.

3. Move to **Use stealth** and press **Edit** to check/clear the box.
4. When stealth is set up and **Use Stealth** is selected in this menu, you can activate and deactivate it from the main screen by selecting **Options > Stealth**.

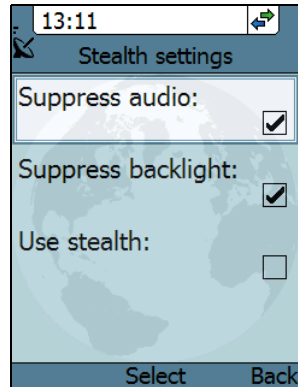

To set call services (Noise cancellation)

The IP Handset has efficient noise suppression software which you can switch on or off, depending on the noise level in your environment. Noise cancellation should only be selected when the handset is used in a noisy environment.

To set up Noise cancellation, do as follows:

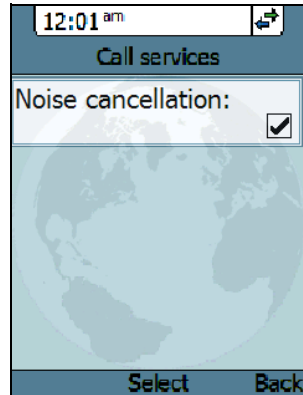

1. From the **Settings** menu, select **Call services**.
2. Press **Select** for **Noise cancellation**.



To set up the function of the cradle

The IP Handset can be operated as hand-held or hands-free. You can select whether the handset should detect the cradle or not.

To set up the cradle settings, do as follows:

1. From the **Settings** menu, select **Cradle**.
2. To have the handset detect whether or not it is in the cradle, check the box. This is the default mode. The function is as follows:
 - You can answer calls by removing the handset from the cradle, and terminate a call by putting the handset back in the cradle.
 - The handset automatically changes to hands-free when you make or answer a call with the handset in the cradle.
 - If you take the handset from the cradle during the call, it automatically changes to hand-held operation.
 - In hand-held mode, when you put the handset in the cradle, the call is terminated.
 - In hands-free mode, when you put the handset in the cradle the call is not affected.
3. To make the handset independent of the cradle, clear the box. This means you must always use  or # and  to start and end calls, and you can only enable or disable hands-free operation by using the keypad.

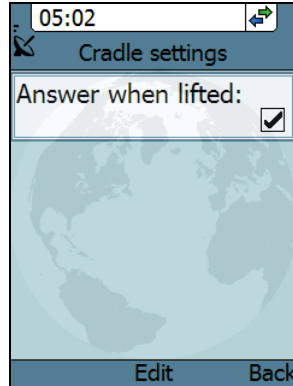

To set up the display

You can customize the following items in the display:

- Active backlight can be adjusted from 10 to 100 percent. The backlight is on for 15 seconds after the last key press.
- Standby backlight can be adjusted from 0 to 50 percent and cannot be set higher than the current Active backlight
- Screensaver, you can select whether the IP Handset should use a screen saver when it is not used for one minute.
- Transparency can be selected.
- Automatic day/night mode can be selected. This automatically gives you optimum display light conditions, also for operation in low light areas. If you do not want to use automatic activation, deselect it. You can still start it manually from the Main Options menu when needed. For further details see *To use night mode* on page 41.

To set up the display settings, do as follows:

1. From the **Settings** menu, select **Display**.
2. Move to the setting you want to change.
3. For the backlight settings, use the keys ◀ and ▶ to change the percentage.
4. For the remaining settings, select **Edit** and select or deselect the item.

Note

Use the down key to scroll down to Automatic Day/night mode.

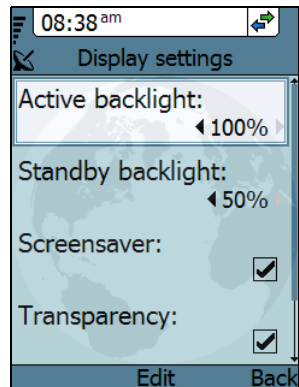

To select the startup options

You can select whether or not you want to clear the log and the Contacts in your handset every time you start up the handset. You can also select whether or not you want handsets to be automatically set up when they are connected to a BGAN terminal.

To select the startup options, do as follows:

1. From the **Settings** menu, select **Start up options**.
2. If you want to clear the logs and the Contacts at every startup, select **Clear logs/Contacts**. To leave the menu, select **Back**.
3. If you want the IP Handset to be set up automatically when it connects, select **Auto BGAN SIP** (selected by default).

With this option selected, from next startup, the IP Handset will automatically be set up with the next available user name (local number) and password when connected to a BGAN terminal.

To leave the menu, select **Back**.

To enable or disable the web server

A web server is built into the IP Handset. It is primarily used for uploading software and for editing contacts. You can enable or disable the web server.

To enable or disable the built-in web server, do as follows:

1. From the **Settings** menu, select **Web server**.
2. Select **Edit** to enable or disable the web server. The default settings is enabled (checked).

For information on the web server, see *To use the web server* on page 75.

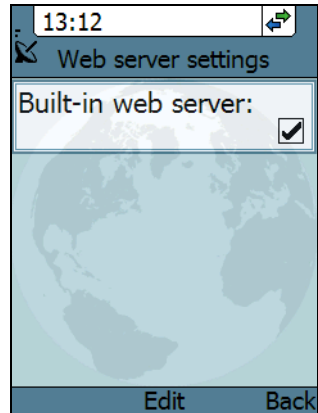

To set the date and time

Note | The date and time is only maintained as long as the handset is powered!

To set the date and time, do as follows:

1. From the **Settings** menu, select **Date and time**.
2. If your handset is connected to a BGAN terminal and you want to use the UTC time received from the BGAN satellite, select **Use BGAN time**. Then leave the menu.
3. If you want to set the date and time manually, clear the **Use BGAN time** box. Then continue to the following steps.
4. To change the time, move to **Time:** and press **Edit**. Then type in the new time and select **OK**. The new time is activated immediately.
5. To change the date, move to **Date:** and press **Edit**. Then type in the new date and select **OK**.
6. To switch the time format between 24h and 12h, use the keys ◀ and ▶, or select **Edit** and select the wanted format.
7. To change the time zone, use the keys ◀ and ▶, or select **Edit** and select the wanted time zone.

Note | Use the down key to scroll down to the last item in this sub menu.

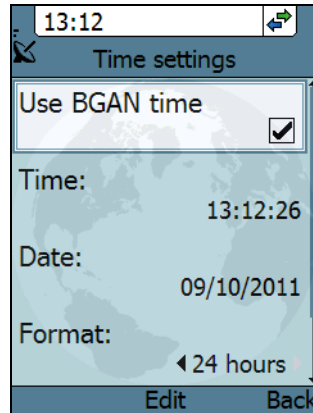

To use a PIN code for the handset

Note

There may be 2 PIN codes for the system:

- one for the BGAN terminal (SIM PIN, described in *To establish a connection* on page 11) and
- one for the IP Handset (described in this section)

If a PIN code is defined for the handset, it must be entered at startup and when the screensaver is active.

Important

If you have entered a wrong PIN code 5 times, the handset is locked! Contact your distributor for an unblocking code.

Note that you **do not have to enter the PIN** to answer the phone when it is ringing.

For information on how to set up the PIN code for the handset, see the next section.

To set up the PIN code for the handset

To set up the PIN code for the handset, do as follows:

1. From the **Settings** menu, select **PIN code**.

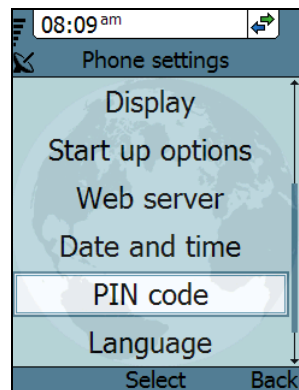

2. Select **Edit**.

If there is already a PIN code for the handset, you must enter this PIN code before you can change it.

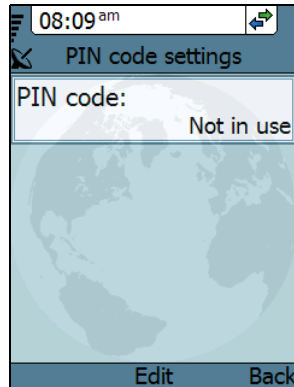

3. Type in the PIN code you want to use and select **OK**.

Note | If you do **not** want to have a PIN code for the handset, leave the field empty and select **OK**.

- 4. Repeat the PIN code and select **OK**.
- 5. Select **Back** to leave the menu.

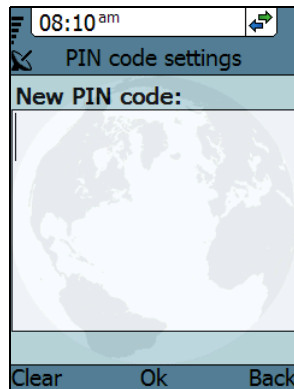

To select the language

This setting is for future use. Only English language is currently available.

To apply factory default settings

You can reset the IP Handset to factory default settings.

To return to factory default for all settings, do as follows:

1. From the **Settings** menu, select **Factory default**.

Important

All settings and status information are lost when you accept this setting!

2. Select **Yes**.

All settings and status information are now changed to factory default settings. Note that in some cases this operation may take up to 30 seconds.

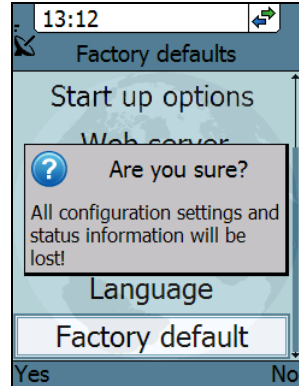

SIP telephony and profiles

The IP Handset has an integrated SIP (Session Initiation Protocol) client used for SIP telephony between the handset and the BGAN terminal, which has an integrated SIP server, or another SIP server. How to set up the SIP profile depends on your subscription and the SIP server and network to which the handset is connected.

To activate a SIP profile

The default profile is the **BGAN** profile, which is used when the IP Handset is connected to a BGAN terminal.

To activate a profile, do as follows:

1. From the main menu, select **SIP**.
2. Move to the profile you want to use for communication, and select **Connect**.

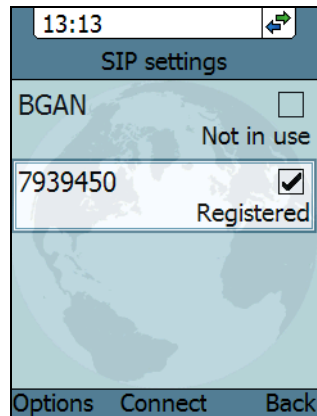

To add a new SIP profile

Add a new SIP profile if you want to connect the SIP client of the IP Handset to a SIP server. You need to enter several network specific values so the handset can communicate with the SIP server. The IP Handset can hold up to 10 profiles.

The following parameters can be set up in the SIP profile:

- Profile name
- SIP server and port
- User name
- Password
- Codec priority
- STUN server
- Reregister interval

To add a new SIP profile, do as follows:

1. In the SIP menu, select **Options** (left select key).
2. Select **Add**.

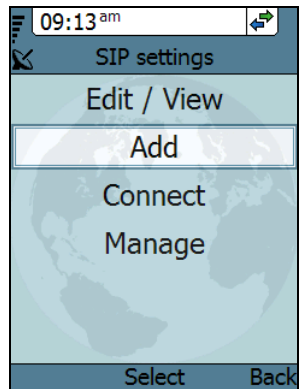

3. Type in the name to use for the new profile and select **OK**.

Example: The profile name is New Profile.

4. Move to **SIP server** and select **Edit**.



5. At **Server name / IP:**, select **Edit** again.

6. Type in the server name (URL) or IP address and select **OK**.

Example: Server name is voip.serv.

7. Type in the port number for the SIP server and select **OK**.

Example: Port number is 5060 (default setting),

8. Select **Back** to continue the setup of the remaining parameters.

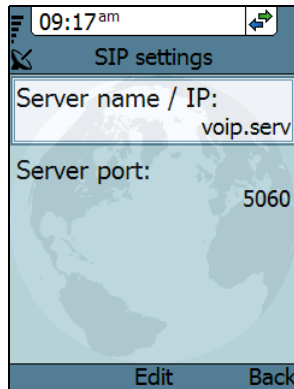

9. Move to the setting you want to change and select **Edit**. Type in the information and enter with **OK**.

Note Use the down key to scroll down to the last items in this sub menu.

- **User name:** When connecting to a BGAN terminal, the user name should be the same as the local number for the handset.
- **Password:** When connecting to a BGAN terminal, the password must match the IP Handset password entered in the terminal.
- **Codec priority:** Select the codec type that should have the highest priority. You may select G711 or G729.
- **STUN server:** If your SIP telephony installation requires a STUN server name, you can enter it here. Refer to the documentation of the SIP server.
- **Reregister every:** This settings sets the time interval in which the IP Handset registers with the SIP server it is connected to. If the SIP server is the BGAN terminal, you don't need to change this setting. The interval is set to 120 seconds (default). The maximum value is 86400 seconds (24 hours).
If the connection to an external SIP provider is made through a NAT router, this setting may be needed to keep the connection through NAT to the SIP server open. This setting should in this case typically be set to 20 seconds.

Note If the IP Handset registers with the SIP server over a satellite connection or other telecommunications network you may set this time interval to a larger value to avoid unintended use of bandwidth.

10. When you have made the changes, select **Back**.
11. If you want to connect immediately with the new SIP profile, select **Connect**. If not, select **Back** to leave the menu.

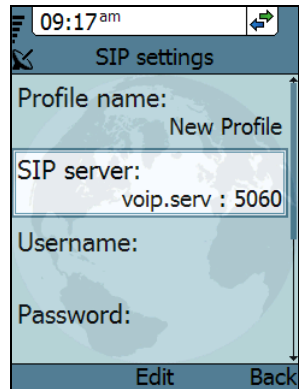

To edit a SIP profile

To edit a SIP profile, do as follows:

1. In the list of profiles, go to the profile you want to change and select **Options > Edit/View**.
2. Edit the settings as described in the previous section.

To delete a SIP profile

To delete a SIP profile, do as follows:

1. In the SIP menu, move to the profile you want to delete and select **Options**.
2. Select **Delete**.
3. Select **Yes**.

To delete all SIP profiles

To delete all SIP profiles, do as follows:

1. From the SIP settings menu, select **Options** (left select key).
2. Select **Manage**.
3. Select **Delete all**.

Important

All profiles except BGAN are deleted - this means that you will only be able to connect your handset using the BGAN profile.

4. Select **Yes**.

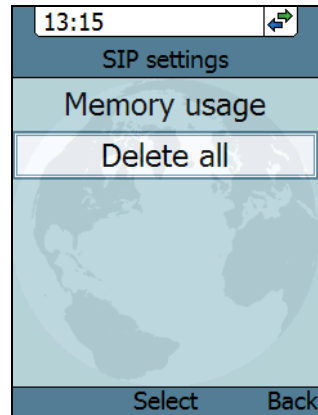

To see memory usage in the list of SIP profiles

To see the number of profiles in the list and the maximum allowed number of profiles, do as follows:

1. From the SIP settings menu, select **Options** (left select key).
2. Select **Manage**.
3. Select **Memory usage**.

Information from the BGAN terminal

When the IP Handset is connected to a BGAN terminal, the handset provides a dedicated **BGAN** menu. Through this menu you have access to a subset of controls and views of the BGAN terminal.

You may find the following items in this menu (depending on configuration):

- **Connect.** You can use the handset with the local number 0501 to start and stop IP background or streaming connections for all network user groups (Only shown when handset 0501 is connected and the connections are set up in the BGAN terminal).
- **Status.** Current GPS position, status, signal strength and PIN status.
- **Properties.** Information about the BGAN terminal type and software version.
- **Enter PIN code.** You can enter the PIN code for the BGAN terminal. (Only shown when the PIN code for the terminal is needed)
- **Active alarms** in the BGAN terminal (if any).
- **Event log.** A list of events that have occurred in the BGAN system.
- **CNo (dBHz).** The signal strength of the BGAN satellite signal shown on a full screen.
- **Voice Distress test** for test of the Voice Distress system (only shown in Voice Distress systems).
- **Terminal usage.** Standard or X-Stream usage mode (only with EXPLORER 727 terminal).

Each item is explained in detail in the following sections. To access the BGAN menu, select **BGAN** from the main menu.

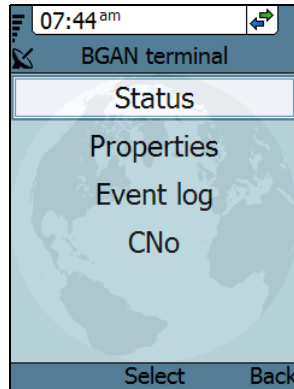

To start and stop IP background or streaming connections (0501 only)

You can use the IP Handset that has the local number 0501 to start or stop data connections set up in the network user groups of the BGAN terminal. The network user groups and types of data connections are configured in the web interface of the BGAN terminal. With this functionality you do not need to connect a PC to the BGAN terminal to start or stop IP background or streaming connections for devices connected to the BGAN terminal.

To start and stop IP standard or streaming connections, do as follows:

1. From the **BGAN** menu, select **Connect**.
2. Use the left/right keys to find the network user group for the application you want to start or stop.
3. Use the up/down keys to select the connection you wish to start (Active) or stop (Inactive).
4. Press **Start** to start a connection, or press **Stop** to stop the connection.
5. A confirmation window is displayed. Press **Yes** to continue.

The IP Handset sends a command to the BGAN terminal to start or stop the selected connection. Check the handset at regular intervals that the connection is still running.

If the connection could not be started by the BGAN terminal, the check mark will be removed, the connection is inactive and the command **Stop** has changed to **Start**.

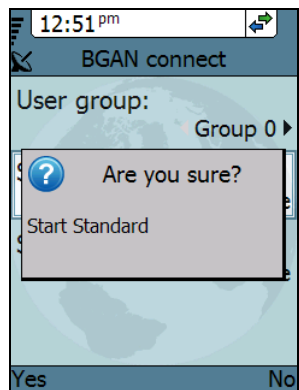
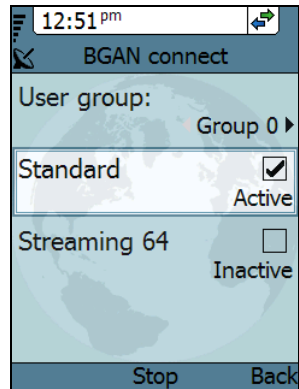

For detailed information about using IP data connections and setting up network user groups with standard and streaming profiles refer to the BGAN terminal's user manual.

Note

Optimize airtime and bandwidth usage: You must manually stop the connection when not used any longer. Note that you are charged for the bandwidth used and the data transferred.

To see BGAN status information

To see the BGAN status, do as follows:

1. From the **BGAN** menu select **Status**.

The status menu shows the following information:

- **GPS position** shows the current position of the BGAN system.
- **Status** shows the status of the BGAN connection, for example Ready or Registering.
- **CNo** shows the signal strength of the BGAN connection (the carrier-to-noise ratio).
- **PIN status** shows status of the PIN, for example whether the terminal is waiting for a PIN.



To see the BGAN terminal properties

To see the BGAN terminal type and software version, do as follows:

1. From the **BGAN** menu select **Properties**.
2. Click **Ok** or **Back** to return to the **BGAN** menu.

To enter the PIN for the BGAN terminal

Note that this menu item is only available if the BGAN terminal is waiting for a PIN.

To enter the PIN for the BGAN terminal, do as follows:

1. From the **BGAN** menu select **Enter PIN code**.
2. Type in the Administrator user name for the BGAN terminal and select **OK**.
For information on how to type text in the handset, see *How to enter text in the IP Handset* on page 42.
3. Type in the Administrator password for the BGAN terminal and select **OK**.
4. Type in the PIN for the BGAN terminal and select **OK**.



Alarm from the BGAN terminal

You can use the IP Handset to alert you when there is a critical alarm in the BGAN terminal. A critical alarm covers warnings and error messages issued by the BGAN terminal.

Press **Details** to see further information about the alarm, or press **Exit** to return to normal phone operation.

As long as the alarm condition is present in the terminal the yellow alarm icon is displayed in the handset display. When there is no active alarm in the terminal, the alarm icon disappears.

Refer to the BGAN terminal's user manual for further details on critical alarms and how to solve them.

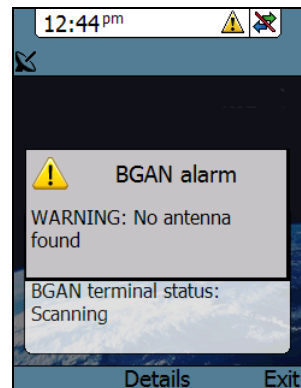

To display active alarms from the BGAN terminal

Besides the alarm alert you can display a list over active alarms and click for details for each active alarm.

To read BGAN terminal alarms, do as follows:

1. From the main menu, select **BGAN**.
2. If there are active alarms in the BGAN terminal, you can select **Active alarms**.
3. Press **Select** to access the list of active alarms.
4. Scroll to an alarm and press **Select** to display details about this particular alarm.
5. Press **Ok** or **Back** to return to normal phone operation.

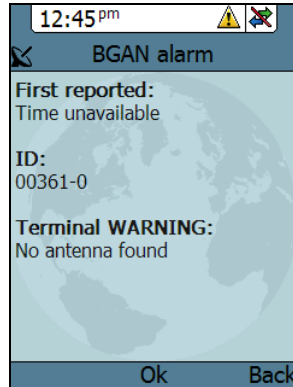

To view the event log

The event log shows events that have occurred in the BGAN system. To see the event log, do as follows:

1. From the main menu, select **BGAN**.
2. Select **Event log**.
3. Scroll to an event and press **Select** to see details for the event.
4. Press **Ok** or **Back** to return to normal phone operation.

To display the signal strength

The handset display can show the signal strength of the BGAN satellite signal when the handset is not in use.

Note While the signal strength screen is displayed, the screensaver is disabled.

To display the signal strength in the handset, do as follows:

1. From the main menu, select **BGAN**.
2. Select **CNo**.

The handset now shows a full screen with the signal strength of the BGAN signal.

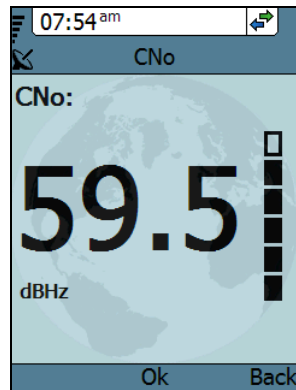

Voice Distress system only: To make a Voice Distress test

If you have a BGAN terminal, a SAILOR 3771 Alarm Panel and a subscription that includes Voice Distress, you can use and test the Voice Distress function.

The handset must show  (designated for Distress) to be able to make Voice Distress calls. This is set up in the BGAN terminal.

For details on how to make a Voice Distress call and a Voice Distress test, see the *Voice Distress (Non-SOLAS) User manual*.

EXPLORER 727 only: To change the terminal usage

If the connected BGAN terminal is an EXPLORER 727 terminal, you can switch between the usage modes Standard and BGAN X-Stream, using the Terminal usage menu item.

For information on the usage modes, see the user manual for the EXPLORER 727 system.

To use the web server

This chapter describes how to use the web server in your IP Handset system.

Introduction to the web server

The web server is built into the IP Handset and is primarily used for uploading software and for editing contacts in the IP Handset.

You can access the web server from a computer connected to the BGAN terminal you are using for the handset. Use a standard Internet browser.

Browser settings

If you are connecting your computer using a LAN or WLAN interface, the **Proxy server** settings in your browser must be disabled before accessing the web interface. Most browsers support disabling of the Proxy server settings for one specific IP address, so you can disable Proxy server settings for the web interface only, if you wish. Consult your browser help for information.

To disable the use of a Proxy server completely, do as follows:

Note | The following description is for **Microsoft Internet Explorer**. If you are using a different browser, the procedure may be different.

1. In Microsoft Internet Explorer, select **Tools > Internet Options > Connections > LAN Settings**.

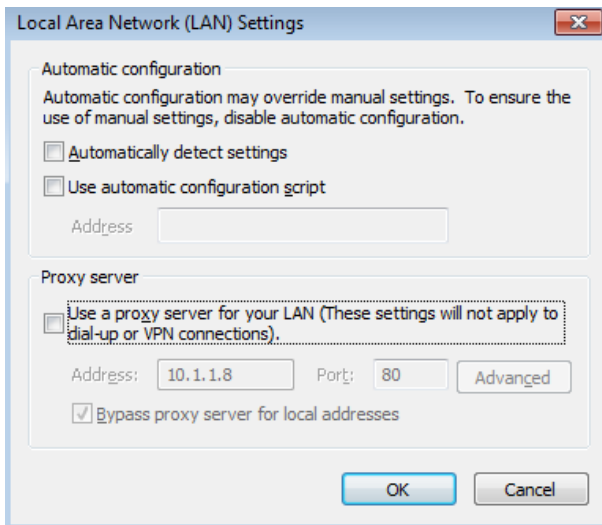

2. Clear the box labeled **Use a proxy server for your LAN**.
3. Click **OK**.

When the proxy server settings are disabled, close and restart your browser. You may need to change this setting back on return to your Internet connection.

Access and navigate the web server

Note

The following procedure is valid if the IP Handset is used together with a BGAN terminal.

To access the web server of the IP Handset

To access the web server from a computer, do as follows:

1. Start up your computer, the BGAN terminal and the IP Handset.
2. Connect your computer to the BGAN terminal using a standard LAN cable.
3. Connect your IP Handset to the BGAN terminal as described in *Get started* on page 5.
4. Open your browser on the computer and enter the IP address of the IP Handset. You find the IP address in the handset menus under **Status > Network information**.

Another way to access the web server of the IP Handset is to click on the page **SETTINGS > IP handsets > Configure** link in the web interface of the BGAN terminal.

You can also see the IP address in the web interface of the terminal on the page **SETTINGS > IP handsets**. Move the cursor to **Configure** for the handset. Its IP address is shown in the status line in the lower left corner of the window.

Overview of the web server

The web server consists of the following sections.

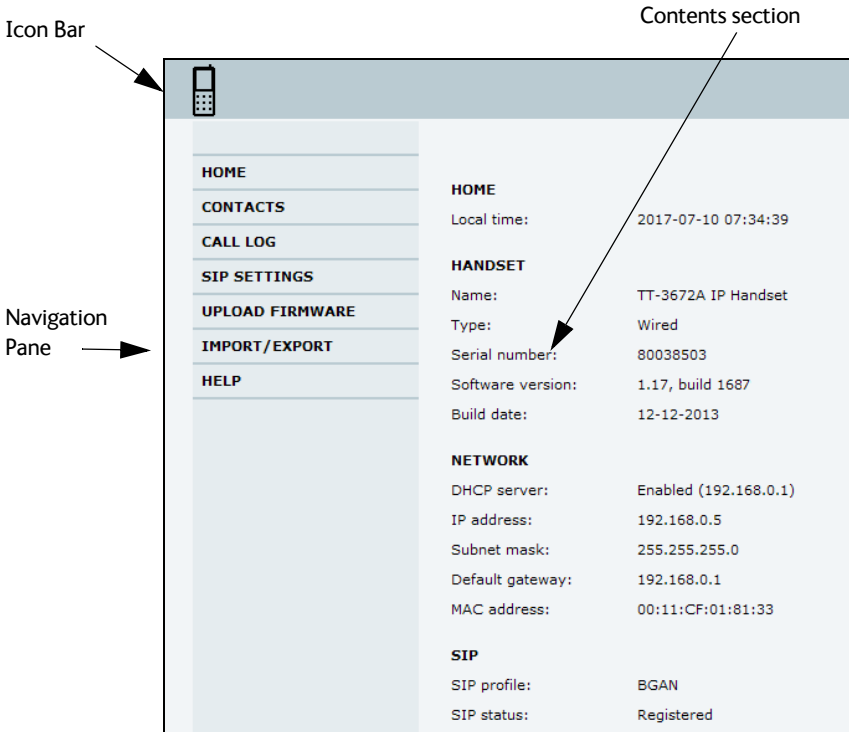

- The **navigation pane** holds the main menu. Clicking an item in the menu opens a submenu in the navigation pane or a new page in the contents section.
- The **icon bar** shows a handset icon to indicate that it is the internal web server of the IP Handset (and not of a BGAN terminal).
- The **contents section** shows the page selected in the navigation pane. This section is used for viewing or changing settings, or for performing actions.

To use the web server

The Home page

The web server starts up on the Home page. To go back to the Home page from another location in the web server, select **Home** from the left navigation pane.

The Home page shows properties and network settings of the handset. The page is automatically updated every 5 seconds.



The screenshot displays the Home page of a web server interface. On the left is a vertical navigation pane with a handset icon at the top and the following menu items: HOME, CONTACTS, CALL LOG, SIP SETTINGS, UPLOAD FIRMWARE, IMPORT/EXPORT, and HELP. The main content area is divided into sections: HOME, HANDSET, NETWORK, and SIP. The HOME section shows the local time as 2017-07-10 07:34:39. The HANDSET section lists: Name (TT-3672A IP Handset), Type (Wired), Serial number (80038503), Software version (1.17, build 1687), and Build date (12-12-2013). The NETWORK section lists: DHCP server (Enabled (192.168.0.1)), IP address (192.168.0.5), Subnet mask (255.255.255.0), Default gateway (192.168.0.1), and MAC address (00:11:CF:01:81:33). The SIP section lists: SIP profile (BGAN) and SIP status (Registered).

HOME	
Local time:	2017-07-10 07:34:39
HANDSET	
Name:	TT-3672A IP Handset
Type:	Wired
Serial number:	80038503
Software version:	1.17, build 1687
Build date:	12-12-2013
NETWORK	
DHCP server:	Enabled (192.168.0.1)
IP address:	192.168.0.5
Subnet mask:	255.255.255.0
Default gateway:	192.168.0.1
MAC address:	00:11:CF:01:81:33
SIP	
SIP profile:	BGAN
SIP status:	Registered



Contacts

The web server gives access to the Contacts list of the handset.

Select **CONTACTS** from the left navigation pane. The page shows the name and number of all contacts in the handset.

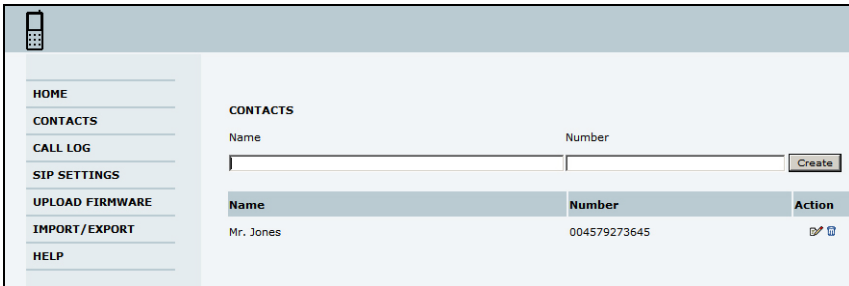
You can sort the list by name or number by clicking **Name** or **Number** in the heading row of the list.



- To add a new contact, type in the name and number at the top of the page and click **Create**. The Contacts list can hold 100 entries.
- To delete a contact, click  next to the contact you want to delete.
- To edit a contact, click  next to the contact you want to edit, and make your corrections.

Call log

To display the call log of the handset, select **CALL LOG** from the left navigation pane.

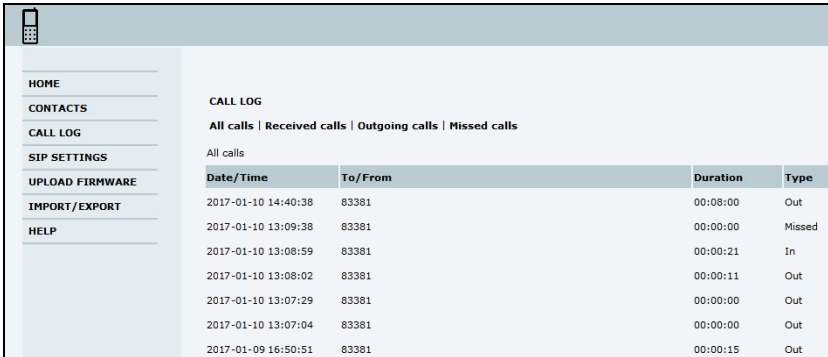

The screenshot shows a web interface for a handset. On the left is a navigation menu with options: HOME, CONTACTS, CALL LOG, SIP SETTINGS, UPLOAD FIRMWARE, IMPORT/EXPORT, and HELP. The main content area is titled 'CALL LOG' and includes sub-links for 'All calls', 'Received calls', 'Outgoing calls', and 'Missed calls'. Below this is a table of call records.

All calls				
Date/Time	To/From	Duration	Type	
2017-01-10 14:40:38	83381	00:08:00	Out	
2017-01-10 13:09:38	83381	00:00:00	Missed	
2017-01-10 13:08:59	83381	00:00:21	In	
2017-01-10 13:08:02	83381	00:00:11	Out	
2017-01-10 13:07:29	83381	00:00:00	Out	
2017-01-10 13:07:04	83381	00:00:00	Out	
2017-01-09 16:50:51	83381	00:00:15	Out	

For each call the **CALL LOG** page shows date and time, phone number, duration and whether the call was incoming, outgoing or missed. If the phone number is in the Contacts list, the name of the contact is shown with the number. The latest calls are listed first.

If you only want to see a subset of the calls, select one of the sub-groups at the top of the page. You can select **Received calls**, **Outgoing calls** or **Missed calls**.

SIP settings

Overview

The handset communicates using SIP (Session Initiation Protocol).

To view the SIP settings of the handset, select **SIP SETTINGS** from the left navigation pane. The page shows the settings for the current SIP profile.

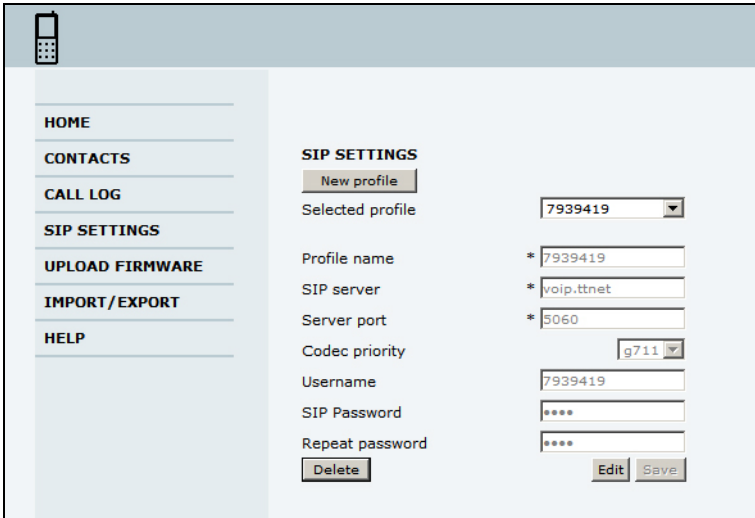

To add a new SIP profile

The list of SIP profiles can hold maximum 10 profiles. To add a new profile, do as follows:

1. Click **New profile** at the top of the page.
2. Fill in the list.
You may not need to fill in all items in the list. Mandatory fields are marked with *.
3. Click **Save** at the bottom of the page.

To edit a SIP profile

To edit a SIP profile, do as follows:

1. From the **Profile** scroll list select the profile you want to edit.
2. Change the settings according to your needs.
3. Click **Save** at the bottom of the page.

To delete a SIP profile

To delete a SIP profile, do as follows:

1. From the **Profile** scroll list select the profile you want to delete.
2. Click **Delete** at the bottom of the page.

To upload firmware

You can use the web server to upload firmware from your computer to the IP Handset.

To upload firmware, do as follows:

1. Select **UPLOAD FIRMWARE** from the left navigation pane.

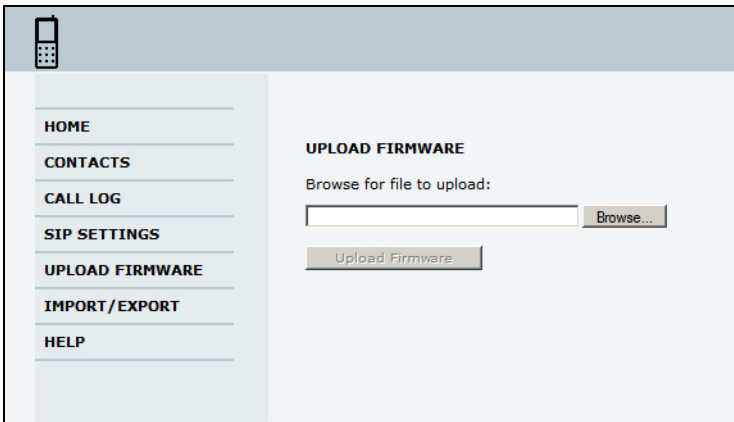

2. Click **Browse** and locate the firmware you want to upload to the IP Handset.
3. Click **Upload firmware**.

The handset initiates firmware upload, showing the progress in the display. When upload is done, the handset automatically restarts with the new firmware.

Note

After uploading firmware to the handset, you may have to refresh your Internet browser for the web server to display correctly. To refresh the browser, press <F5>.

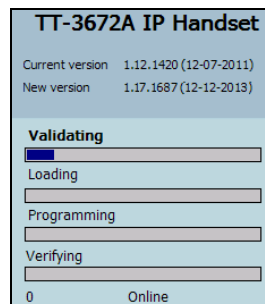

Import and Export settings

If you want to copy settings from one handset to another you can use the Import/Export function. You can import settings to your handset from a file, or export settings from the handset to a file. Select **IMPORT/EXPORT** from the left navigation pane.

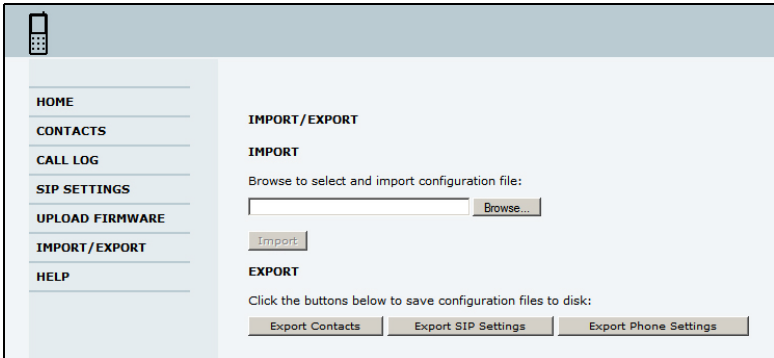

To export settings to a file

You may export three types of settings file, each containing a subset of the handset settings: Contacts, SIP settings or Phone settings. The name of the file indicates which settings are included in the file.

To export a subset of the settings to a file, do as follows:

1. In the **IMPORT/EXPORT** page, click a button under **EXPORT** to create a settings file.
2. Click **Save**, browse to the location where you want the settings file, and click **Save** again.

The file is now saved in the location you specified.

To import settings from a file

You can import three types of settings file, each containing a subset of the handset settings: Contacts, SIP settings or Phone settings. The name of the file indicates which settings are included in the file.

To import a settings file, do as follows:

1. Click **Browse**.
2. Browse to the location where the settings file is saved and select the file you want to import.
3. Click **Open**.
4. Click **Import**.

The selected settings are now replaced by the imported settings.

Help and diagnostics report

The IP Handset can generate a diagnostics report. This report includes information that can be very useful for a service technician. If you are reporting an error with your IP Handset, you may be asked to provide a diagnostics report. To save a diagnostics report, do as follows:

1. Select **HELP** from the left navigation pane.

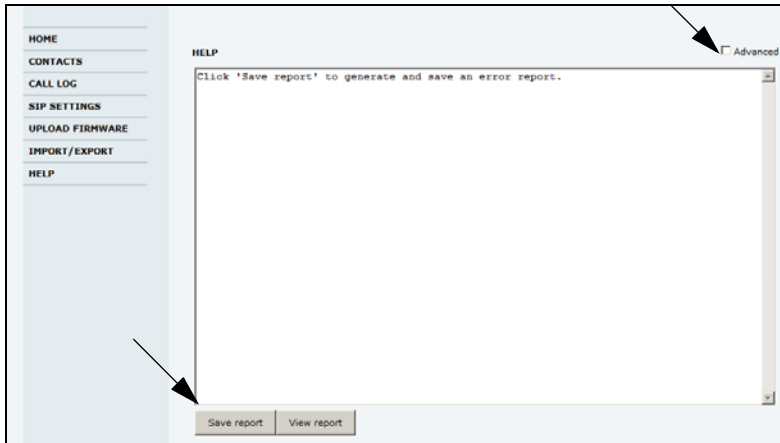

2. Click **Save report**.
3. If your service technician needs specific information included in the report, select **Advanced** in the top right corner and then select the items needed. Click **Save report**.



Service & maintenance

This chapter gives guidelines for getting support, general maintenance tasks and troubleshooting.

Get support

If this manual does not provide the information required to solve your problem, you may want to contact your Airtime Provider or your supplier.

If you can see that the problem is related to airtime and not to the IP Handset, please contact your Airtime Provider

If you need assistance with problems caused by the IP Handset, please call a distributor in your area. You may be asked to generate a diagnostics report. For information on how to generate a report, see *Help and diagnostics report* on page 87.

An updated list of distributors is available on Cobham SATCOM's web site: cobham.com/satcom, select **Technical Service Partner List**.

Maintenance tasks

Software update

For instructions how to make a software update see *To upload firmware* on page 84.

Clean the IP Handset

Wipe the IP Handset or cradle with a clean dry cloth if they become dirty. Make sure that the charging contacts of the handset and cradle are clean.

Disposal of the IP Handset

Old electrical and electronic equipment marked with this symbol can contain substances hazardous to human beings and the environment. Never dispose these items together with unsorted municipal waste (household waste). In order to protect the environment and ensure the correct recycling of old equipment as well as the re-utilization of individual components, use either public collection or private collection by the local distributor of old electrical and electronic equipment marked with this symbol.



Contact the local distributor for information about what type of return system to use.

Troubleshooting guide

The below table provides information on some of the problems that might occur, including possible causes and remedies to solve the problems.

Problem	Possible Cause	Remedy
The handset is not responding to any keys pressed.	An error occurred in the software.	Press and hold the on hook key for at least 10 seconds to switch off the handset. Then switch on the handset again.
No connection to the BGAN network.	1) The PIN code has not been entered in the BGAN terminal, 2) There is an error in the terminal or the BGAN network.	1) Enter the menu system of the handset and select BGAN > Enter PIN code . For information on how to enter the PIN, see <i>Establish a connection using BGAN terminal</i> on page 11. 2) See the manuals for the BGAN terminal for information on how to troubleshoot errors.
The handset shows "SIP fault"	No SIP profile is selected, the selected SIP profile is invalid, or the user name or password is wrong.	Enter the menu system and select SIP to see the selected profile. Change the profile or select another profile if necessary. For further information, see <i>SIP telephony and profiles</i> on page 62.

Technical specifications

This appendix contains specifications and outline drawings for the IP Handset and cradle.

IP Handset specifications

Item	Specification
Type	TT-3672A Thrane IP Handset, wired
Dimensions (L x B x H)	152 mm x 55 mm x 26.5 mm
Weight	190 g \pm 20 g (without cable)
Display	2.2", 240 x 320 pixel TFT color LCD
Operating temperature	-25°C to +45°C
Storage and transport temperature	-25°C to +55°C
Humidity	Up to 95% without condensation
Air pressure, transport	4572 m AMSL
Power	Power over Ethernet (PoE) class 2 (Alternative B of IEEE802.3af is not supported.)
Power consumption	Max. 7 Watt
Protection category	IP55, dust proof and splash proof
LAN interface	10/100 Mbps
Network Protocol	Internet Protocol (IP)

Appendix A: Technical specifications

Item	Specification
VoIP Protocol	SIP v2 Session Initiation Protocol (RFC3261), SDP (RFC2327)
Voice Codecs	G711 and G729
Physical interfaces	RJ-45 male connector on fixed cable Headset 3.5 mm SMT phone jack Not currently used: Mini-USB 5-pin
Certifications	FCC, CE
Compass safe distance, combined handset and cradle	80 cm @5,4° flux of 0,094 uT and 55 cm @18° flux of 0,313 uT

IP Handset outline dimensions

Weight of Handset:
 175 gram +/- 20 gram
 Exclusive Wire

Dimensions are in millimeters

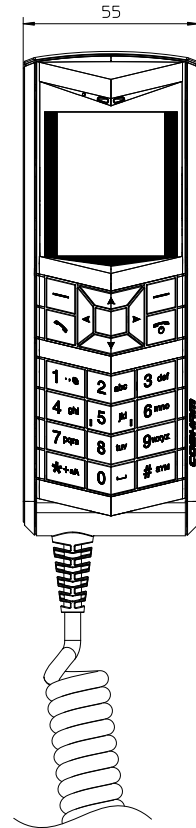
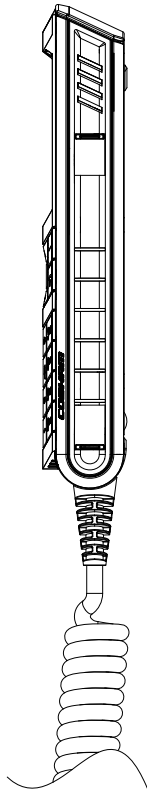
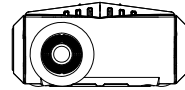

PERSPECTIVE VIEW

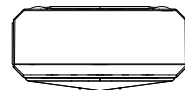

IP Handset outline dimensions, continued (side view and back view).

Dimensions are in millimeters

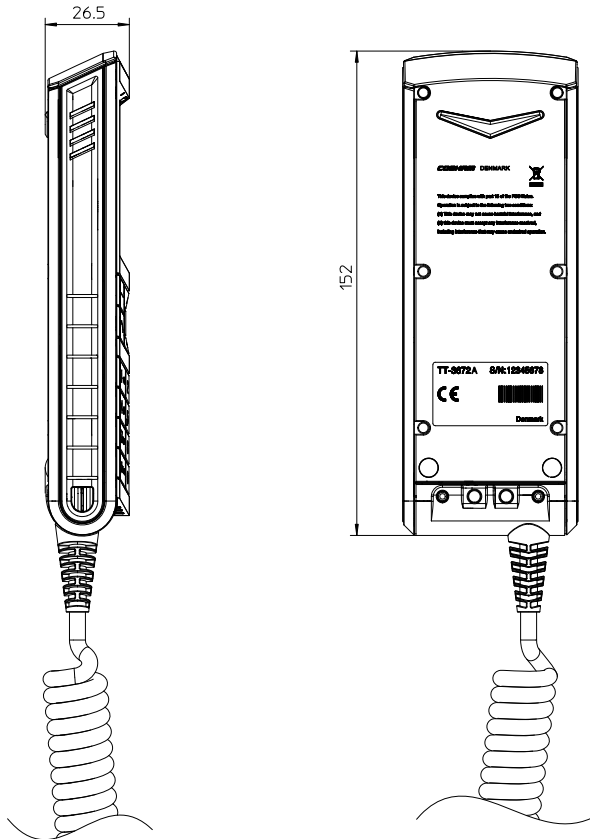

IP cradle outline dimensions

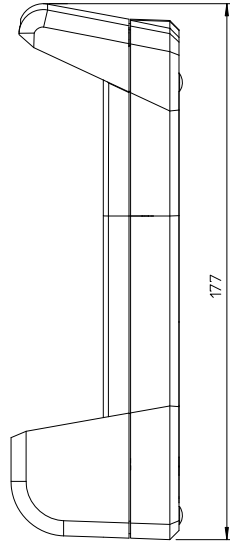
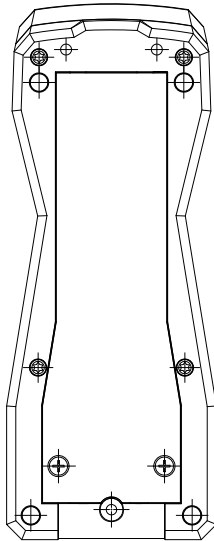
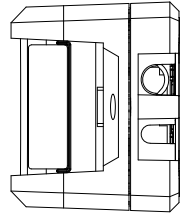

Perspective view

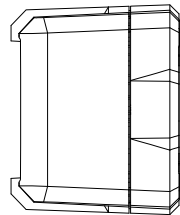
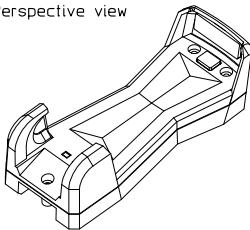

IP cradle outline dimensions, continued (front and side).

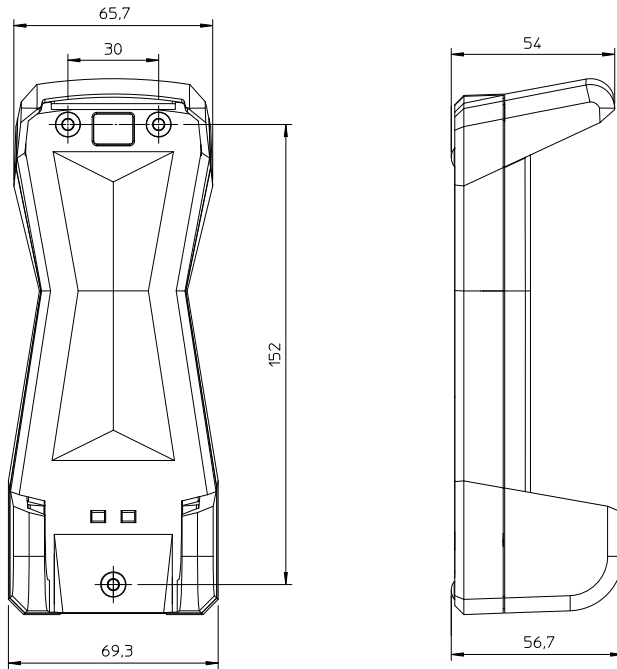

Conformity

Thrane IP Handset, wired

CE (LVD & EMC)

The Thrane IP Handset, wired, is CE certified (LVD & EMC directives) as stated in the simplified “EU Declaration of Conformity”, enclosed in copy on the next page.

FCC

This equipment has been tested and found to comply with the limits for a Class A digital device, pursuant to Part 15 of the FCC Rules. These limits are designed to provide reasonable protection against harmful interference when the equipment is operated in a commercial environment. This equipment generates, uses, and can radiate radio frequency energy and, if not installed and used in accordance with the instruction manual, may cause harmful interference to radio communications. Operation of this equipment in a residential area is likely to cause harmful interference in which case the user will be required to correct the interference at his own expense.

NOTICE:

This device complies with Part 15 of the FCC Rules.

Operation is subject to the following two conditions:

1. this device may not cause harmful interference, and
2. this device must accept any interference received, including interference that may cause undesired operation.

Changes or modifications made to this equipment not expressly approved by Cobham SATCOM may void the FCC authorization to operate this equipment.

EU Declaration of Conformity

Hereby **Thrane & Thrane A/S trading as Cobham SATCOM** declares that the following equipment complies with the specifications of:

EMC directive 2014/30/EU relating to electromagnetic compatibility and
Low Voltage Directive (LVD) 2014/35/EU related to Low Voltage Safety

Equipment included in this declaration

Model	Description	Part no.
TT-3670A	IP Handset & Cradle, Wired	403670A

The full text of the EU declaration of conformity is available at the following internet address:

<http://sync.cobham.com/satcom/support/downloads>

Document no.: 99-157672-A

B

BGAN Broadband Global Area Network. A satellite network based on geostationary satellites, delivering broadband data and telephony to virtually any part of the earth, with full UMTS (3G) compatibility. BGAN enables users to access e-mail, corporate networks and the Internet, transfer files and make telephone calls.

C

CE Conformité Européenne. This term signifies that a CE certified product conforms to European health, environmental, and safety regulations. It makes the product legal to be sold in the European Union.

D

DHCP Dynamic Host Configuration Protocol. A protocol for assigning dynamic IP addresses to devices on a network. With dynamic addressing, a device can have a different IP address every time it connects to the network.

DNS Domain Name Server. A system translating server names (URLs) to server addresses.

I

IEEE Institute of Electrical and Electronics Engineers. IEEE is a non-profit organization and the world's leading professional association for the advancement of technology.

IMSO International Mobile Satellite Organisation. An intergovernmental organisation that oversees certain public satellite safety and security communication services provided via the Inmarsat satellites.

IP Internet Protocol. The method or protocol by which data is sent from one computer to another on the Internet.

L

LAN Local Area Network

M

MAC Media Access Control address. A hardware address that uniquely identifies each node of a network.

N

NAT Network Address Translation.

P

PCB Printed Circuit Board

PIN Personal Identification Number. A secret numeric password shared between a user and a system, used to authenticate the user to the system.

PoE Power over Ethernet. A standard for combining power supply with transmission of data over the Ethernet. The source unit "injects" power into the Ethernet cable and the power is "picked up" at the connected device.

PUK PIN Unblocking Key. An eight-digit code used to unblock a SIM card after three incorrect PINs have been entered. The PUK code is supplied with the SIM card.

Q

QVGA Quarter Video Graphics Array. A popular term for a computer display with 320 × 240 resolution. QVGA displays are often seen in mobile phones, PDAs and some handheld game consoles.

S

SIM Subscriber Identity Module. The SIM provides secure storing of the key identifying a mobile phone service subscriber but also subscription information, preferences and storage of text messages.

SIP Session Initiation Protocol. An application-layer control (signalling) protocol for creating, modifying, and terminating sessions with one or more participants. Used e.g. for Internet telephony.

SOLAS (International convention for the) Safety Of LIfe At Sea. Generally regarded as the most important of all international treaties concerning the safety of merchant ships.

STUN Simple Traversal of UDP through NATs, a protocol for assisting devices behind a NAT firewall or router with their packet routing.

T

TFT Thin Film Transistor. A display type using a number of individual display cells, each controlled by its own transistor.

U

URL Uniform Resource Locator. A name used to describe the address of a specific resource on the internet.

V

VoIP

Voice over Internet Protocol. The routing of voice conversations over the Internet or through an IP-based network.

Numerics

- 3.1 kHz Audio number, 38
- 501 phone number
 - data connections, 68
- 870, call, 38

A

- active alarms
 - BGAN, 72
- adjust
 - backlight, 55
 - sound, 51
 - standby backlight, 55
 - volume during call, 39
- alarm
 - active BGAN, 72
 - alert BGAN, 71
- answer when lifted, 54
- audio
 - suppress, 52
- Auto BGAN SIP, 11, 56
- automatic IP address, 50
- automatic setup, 11, 56

B

- backlight, 55
 - adjust, 55
 - standby, adjust, 55
 - suppress, 52
- BGAN
 - call using, 38
 - enter PIN, 71
 - menu, 69
 - status information, 70

- BGAN critical alarms, 72
- BGAN software version, 70
- BGAN terminal, 15
 - setup, 15
- BGAN terminal type, 70

C

- cable relief, 7
- call
 - +870, 38
 - ending or rejecting, 38
 - from BGAN terminal, 38
 - making, 16, 30
 - receiving, 32
 - transferring, 32
- call log, 81
 - add number to contacts, 45
 - delete a number, 46
 - delete all numbers, 46
 - manage, 45
 - memory usage, 46
- call services, 53
- CE compliance, 99
- change hands-free mode, 40
- clear log
 - automatically, 56
- CNo, 70
- codec
 - G711, 65
 - G729, 65
- codec priority
 - SIP profile, 65
- compass safe distance, 94
- configure
 - web interface, 15
- conformity, 99

- connecting
 - BGAN terminal, 9
- connecting cradle
 - LAN cable, 7
- connecting the handset, 6
- connection, start
 - IP background, 69
 - IP streaming, 69
- connector
 - cradle, 6
- connectors, 6
- contact information, 89
- contacts, 47
 - add, 47, 80
 - call, 47
 - clear automatically on startup, 56
 - delete, 48, 80
 - display, 47
 - edit, 48, 80
- control functions
 - BGAN terminal, 1
- control keys, 18
- cradle
 - connector, 6
 - detection, 54
 - dimensions, 97
 - installing, 8
 - measures, 8
 - outline, 97
- critical alarm
 - display, 71

D

- date and time setting, 58
- day/night mode, automatic, 55
- Declarations of Conformity, 100

- Default gateway
 - show, 49
- default settings, 61
- DHCP, 50
- diagnostics report, 87
- dialled number, 45
- dimensions
 - cradle, 97
 - handset, 95
- display
 - icons, 25
 - night colors, 41
 - overview, 23
 - settings, 55
- disposal
 - IP Handset, 90
 - rules for, iii
- Distress
 - call, 2, 73
 - test, 2, 73
- DNS
 - primary and secondary, enter, 50
- document number
 - this manual, i

F

- factory default, 61
- FCC compliance, 99
- features, 3
- firmware
 - uploading, 84

G

- G711 codec, 65
- G729 codec, 65

gateway
 enter, 50
Getting started, 5
GPS position, 70

H

hand-held mode, 40
handset, 14
 connecting, 6
 connecting to BGAN terminal, 9
 dimensions, 95
 features, 3
 outline, 95
 PIN, 59
 register, 11, 14
hands-free
 change mode, 40
 operation, 39
headset, 42
help, 87
hen, 11

I

icons in display, 25
identification of the handset, 79
import/export settings, 85
installation
 cradle, 8
IP address
 automatic, 50
 DHCP, 50
 show, 49, 77
 static, 50
IP background
 start connection, 69

IP Handset
 getting to know, 1
 setup, 14
 switch off, 10
 switch on, 10
IP mode, 50
IP streaming
 start connection, 69

K

keypad
 alpha-numeric keys, 20
 click, 51
 control keys, 18
 description, 17
 locking, 40
 shortcuts, 22
keys
 text and symbols, 20

L

LAN cable, 7
local number, 14
 assign automatically, 11, 56
 BGAN terminal, 14
locking the keypad, 40
log
 clear automatically on startup, 56
lowercase mode, 20

M

MAC address, 49
make a call, 16, 30
manual
 document number, i

- memory usage
 - call log, 46
- menus
 - main, 23
- microphone, muting, 40
- missed calls, 45
- mobile number, 38
- muting the microphone, 40

N

- network information, 79
- night mode, 41
 - automatic switch to, 55
- noise cancellation, 53
- number mode, 20

O

- outline
 - cradle, 97
 - handset, 95

P

- password
 - SIP client, 65
- phone book, 47, 80
- Phone settings, 51
- physical address
 - IP Handset, 49
- PIN
 - BGAN, 71
 - for handset, 59
 - wrong PIN, 13
- PIN status, 70
- PoE standard, 9
- port number, 64

- power
 - off, 10
 - on, 10
 - on, off, 17
- Power over Ethernet
 - standard, 9
- PUK code, 13

R

- received calls, 45
- register
 - handset, 11, 14
- reregister
 - SIP server, 65
- reset, 61
- restore factory settings, 61
- ringing tone, 51

S

- safety
 - call, 2, 73
 - voice, 2, 73
- safety call
 - icon, 25
- safety summary, iii
- screensaver, 27, 55
- select a SIP profile, 62
- serial number, 49
- set up, 15
 - IP Handset, 14
- setup
 - automatic, 11, 56
- signal strength, 70
- SIP client, 62
 - password, 65
 - user name, 65

- SIP fault, 91
 - SIP profiles, 82
 - activating, 62
 - adding, 63, 83
 - codec priority, 65
 - deleting, 66, 83
 - editing, 66, 83
 - selecting, 62
 - SIP server, 63
 - name, 64
 - port number, 64
 - reregister, 65
 - STUN, 65
 - SIP telephony, 62
 - software error, 91
 - software upload, 84
 - software version
 - BGAN terminal, 70
 - IP Handset, 49, 79
 - sound
 - adjust, 51
 - specifications, 93
 - standard voice number, 38
 - standby backlight, 55
 - startup options, 56
 - static IP address, 50
 - status, 70, 79
 - stealth mode
 - on, off, 52
 - quick setting, 41
 - setting up, 52
 - streaming connection
 - start, 69
 - STUN server
 - SIP server, 65
 - Subnet mask address
 - show, 49
 - support, 89
 - diagnostics report, 87
 - switch off
 - IP Handset, 10
 - switch on
 - IP Handset, 10
- ## T
- technical specifications, 93
 - terminal type, BGAN, 70
 - test
 - Voice Distress, 73
 - text mode, 20
 - text, writing in display, 42
 - time setting, 58
 - tone volume, 51
 - transfer a call, 32
 - transparency, 55
 - troubleshooting guide, 91
 - typography used in this manual, ii
- ## U
- unlock, 13
 - uploading firmware, 84
 - uppercase mode, 20
 - user interfaces, 29
 - user name
 - SIP client, 65
- ## V
- Voice Distress, 2, 39
 - icon, 25
 - test, 68
 - Voice Distress test, 73
 - volume
 - adjusting during call, 39
 - up or down, 19

W

web server

- accessing, 77

- browser settings, 76

- call log, 81

- contacts, 80

- enabling or disabling, 57

- Home, 79

- import/export settings, 85

- introduction, 75

- overview, 78

- SIP settings, 82

- using, 75

- writing text in display, 42

X

- X-Stream, 68

