

OPERATOR MANUAL
DSC

HF SSB RM2152

SAILOR COMPACT 2000 PROGRAMME

Introduction

S. P. Radio A/S

For more than half a century S. P. Radio A/S has been the market leader within maritime radio communication.

Sailor

The communication products and systems of S. P. Radio are recognized under the brand name Sailor. The Sailor name has become a guarantee of reliable and technologically superior radio equipment, ranging from basic VHF units to satellite systems and complete compact GMDSS solutions.

Products

The SAILOR COMPACT 2000 GMDSS is based on the well proven range of Sailor products specifically developed to meet the GMDSS requirements and supported by a world-wide Certified GMDSS service concept, giving several hundred reasons for shipping companies to choose equipment manufactured by S. P. Radio A/S. Today S. P. Radio A/S is recognized as the world's leading supplier of GMDSS solutions.

The SAILOR COMPACT 2000 GMDSS has already been and still is constantly supplied to a large number of the world's leading shipping companies and national naval fleets. It is a complete GMDSS solution which matches communication and safety needs exactly - regardless of whether you operate with A1, A2, A3 or A4.

The System 4000 GMDSS sets new standards. It is constructed on the basis of our comprehensive experience developing GMDSS equipment. It satisfies all the relevant requirements regarding safety and efficiency. The System 4000 presents a large number of attractive convenience and safety facilities, either as a complete solution or as a series of stand-alone products.

Sailor has a long history as a satellite communications supplier offering a full programme of satellite systems which includes Mini M, SAT-C and a number of stationary satellite systems. Our SAT-B is a breakthrough in maritime aerial technology and reliability. The SAT-B is the best possible choice when high quality speech transmission, top level security and the capacity to deal with large volumes of telex, fax, data and high-speed data (HSD) transmissions are required.

Training certification

Training of deck officers to meet the requirements within the concept of GMDSS, as to operation of equipment and basic understanding of the systems, is an extremely important factor for the overall successful implementation of GMDSS. As a unique initiative for GMDSS solutions, we can supply a complete software training programme for on-board training, to be used as preparation in order to fulfil the GMDSS requirements for obtaining the General Operation Certificate.

Service

A world-wide Sailor GMDSS certified service concept has been established in order to provide the shipping industry with a highly professional and uniform level of service. The Sailor GMDSS Certified Service Centre concept, which is constantly monitored, ensures that replacement units and spare parts are available at all the Sailor Certified Service Centres around the world. Service centres which are in position along all the major shipping routes. Furthermore the Certified Service Centres ensure that technicians with an annually updated training are ready to provide service 24 hours a day, 365 days a year.

Maintenance

Because of the fact that GMDSS equipment has been installed on board ships in order to meet the SOLAS (Safety of Life At Sea) convention, manufacturers and suppliers of GMDSS equipment have a certain responsibility to secure reliable supplies of equipment and spares in the years to come.

Therefore shipowners operating ships both locally and internationally should be fully aware of the importance of fitting GMDSS solutions which will be fully supported by the manufacturer.

It is a firm policy of S. P. Radio A/S, as the world's major manufacturer and supplier of GMDSS solutions, that for both the present GMDSS solutions and for future, alternative product solutions, all Sailor GMDSS systems will be entering the next century in fully parallel production.

Please note

Any responsibility or liability for loss or damage in connection with the use of this product and the accompanying documentation is disclaimed. The information in this manual is furnished for informational use only, is subject to change without notice, may contain errors or inaccuracies, and represents no commitment whatsoever. This agreement is governed by the laws of Denmark.

Doc. No.: B2152GB0

Issue: A/9950



SAILOR

S.P. RADIO A/S · Porsvej 2 · PO Box 7071 · DK-9200 Aalborg SV · Denmark

Phone: +45 9634 6100 · Fax: +45 9634 6101 · Telex: 69789 SPRAD DK

E-mail: sailor@sailor.dk · Web: www.sailor.dk

CONTENTS

1	INTRODUCTION	
1.1	What is Digital Selective Calling?	1-1
1.2	Your MF/HF DSC Receiver Modem	1-1
1.3	About the Manual	1-1
2	CONTROLS	
3	OPERATION	
3.1	General Operation	3-1
3.2	Display (Simple calls)	3-1
3.3	Display (Extended calls)	3-1
4	SET-UP	
4.1	Modification of the Display Light and the Read-Out Angle	4-1
5	QUICK DISTRESS CALL	
5.1	Undesignated Distress Call	5-1
6	STANDARD CALL	
6.1	Call without Position and Work Frequencies	6-1
6.2	Call with Work Frequencies	6-2
6.3	Call with Position	6-3
7	ADVANCED DSC CALLS	
8	RECEIVED MESSAGE BOOK	
8.1	Looking for an Ordinary Call	8-1
8.2	Looking at a distress call	8-2
9	SCANNING - WATCH RECEIVER	
9.1	Scanning start/stop	9-1
9.2	Stepping	9-1
9.3	Scan Editing	9-2
10	SCANNING - DSC/TELEX RECEIVER	
10.1	Scanning	10-1
10.2	Stepping	10-2
10.3	Scan Editing	10-2
11	TEST FUNCTION	
11.1	Internal Test	11-1
11.2	External Test	11-1
A	CABLES BETWEEN CABINETS	
B	TABLE OF INFORMATION SYMBOLS ABOVE 100	

1 INTRODUCTION

1.1 What is Digital Selective Calling?

Digital Selective Calling (DSC) is a globally adopted general purpose system for selective calling in the ship-to-ship, ship-to-shore and shore-to-ship directions. The system is used on both MF/HF and VHF frequencies.

Digital Selective Calling (DSC) can be used for distress alerting and safety calls and is a major building block in the Global Maritime Distress and Safety System (GMDSS).

Digital Selective Calling (DSC) can be used to automatically set up a public call when a telephony or telex communication is wanted with another mobile unit or a coast station.

1.2 Your MF/HF DSC Receiver Modem

Your MF/HF DSC receiver modem RM2152 complies with the international requirements listed by IMO in the Global Maritime Distress and Safety System also known as GMDSS.

Combined with an HF SSB transceiver and telex, the MF/HF DSC gives you a fully automated system with the option of transmitting automatic acknowledgements of calls as well as access to the automatic services of the coast stations.

On the HF band a different pair of frequencies is used for digital selective calling for both distress calls and ordinary calls. The DSC modem can scan up to 6 frequencies thereby ensuring a continuous watch over ships or coast stations.

The result is that you are able to transmit and receive distress calls as well as selective ship-to-ship or ship-to-shore calls.

In distress situations, distress calls with indication of the vessel's position can be easily initiated by pressing one button only. The distress call is sent to all stations and automatic re-transmissions of the distress call will continue until you receive a distress acknowledgement call.

The individual selective ship-to-ship and ship-to-shore calls can be compared to ordinary telephone calls. You dial a number and wait for the other party to reply. When a reply is received, the DSC modem will automatically set up the communication frequencies and mode.

The encoding of calls is divided into simple and complete calls. Simple calls need a limited amount of information in order to be transmitted. This is so because most calls will be simple ship-to-ship and ship-to-shore calls where a party calls another party stating that he would like to talk on a specific working channel.

1.3 About the Manual

This manual describes the use of the MF/HF DSC receiver modem RM2152. The RM2152 can be configured as an old RM2150 or an old RM2151.

The MF/HF DSC is easy to use because of its menu-guided user interface. The principles and facilities of the user interface are described in Chapter 3 under the headline "Operation".

We recommend that you start by reading Chapter 3, "Operation" in order to understand the basic use of the MF/HF DSC. Transmission of calls using this manual as reference will then be an easy task.

2 CONTROLS



Volume control and ON/OFF switch for the mains



Gives access to a menu consisting of the following sub-menus:

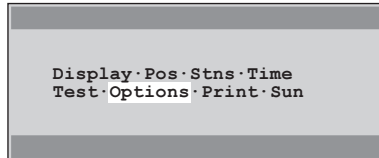

Display Displays the main menu.

Pos Allows you to enter the position of the vessel.

Stns Allows access to the station menu.

Time Allows access to set up date and time

Test Allows an external or internal test.

Options Allows access to the different service programmes.

Print Allows access to print of different tables.

Sun Allows access to set the sunspot number.



Transmit distress call when pressed for 3 sec.



These four keys reset the **RM2152** to its starting position in the main menu. The starting position may vary depending upon the choice of key:



Selects scan menu



Select scan edit menu



Selects menu for received distress call or public calls



Selects menu for short calls to a telephony subscriber



Select menu for extended calls



Starts transmission of DSC call.



The arrow keys are used to move the cursor in the selected menu. NEXT and LAST are used to select the next menu or the previous menu.



Selects previous menu until one of the four main menus appear.



Moves the cursor to the left. If the cursor is placed in a writing space, the cursor moves one step to the left and the information is deleted.



Moves the cursor to the right.



When the displayed menu reads $\hat{\diamond}$ the up arrow can be used to extend the display menu.



When the displayed menu reads $\hat{\diamond}$ the down arrow can be used to extend the display menu.



Select the next menu and confirm the information in the previous menu.



Digits from 0 to 9 and letters from A to Z.



Confirms a key-in sequence and stops transmission of distress calls or general DSC calls.



Set the decimal point or the degree sign.

3 OPERATION

3.1 General Operation

The MF/HF DSC modem RM2152 is operated via menus. Select the function required on the front plate and the menu will guide you through until the display reads Press SEND to call. **SEND** can now be pressed and the DSC modem will set-up the transmitter and hence the DSC call will be initiated.

3.2 Display (Simple calls)

By using the stn command a station from the station table is to be used.

By using the MID command you have to key in the MID number of the station to be called.

In order to make the "MID" sign flash again and revert to "STN" use the left arrow key. This key deletes the information in the writing space and moves the cursor one step to the left, until the "MID" sign flashes and the up / down arrow keys can be used to change to "stn".

3.3 Display (Extended calls)

When pressing **CALL** followed by **EDIT**, the menu Type of Call appears. **SELECTIVE** flashes. If "NEXT" is activated, selective call is chosen. If you wish to change the type of call, use the left and right arrow keys until "Distress" or "All ships" is flashing. If **NEXT** is activated while "Distress" or "All ships" flashes, distress call is chosen.

Press **CALL**

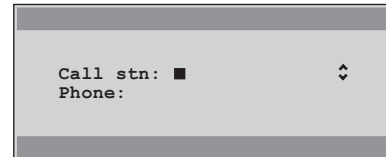

Press  or 

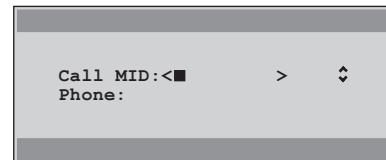

Press **CALL** then **EDIT**

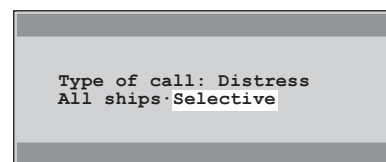

Press  or  

Press **NEXT**

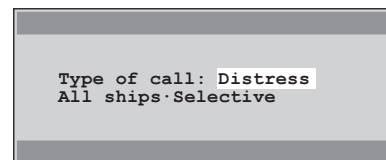

Press  then **NEXT**

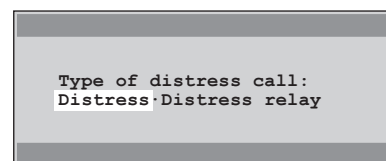

4 SET-UP

4.1 Modification of the Display Light and the Read-Out Angle

The display light and the read-out angle can be set or modified by pressing **FUNC**.

The option "Display" is now flashing in the display. Press **NEXT** to select this option.

The digit following "View angle" option will flash. "View angle" can be set in ten steps from 0 to 7. If the unit is generally seen from above, a high value is recommended. If the unit is generally seen from a lower position, a low value is recommended. Use \wedge or \vee or the numerical keyboard to set the desired value. Press **NEXT** to confirm and return to the **FUNC** main menu, unless you want to change the light intensity setting too.

The display light / keyboard light can be set in four steps from 0 to 3, when the digit following "Light" is flashing.

- 0 - no display light / keyboard light.
- 1 - lowest display light and keyboard light.
- 2 - medium display light and no keyboard light.
- 3 - full display light and no keyboard light.

Use \wedge or \vee or the numerical keyboard to set the desired value.

Press **NEXT** to confirm settings and exit to the **FUNC** main menu.

All other functions in the "FUNC" menu can be operated in similar way:

DISPLAY	Modification of the display light and the read-out
POS	Changing position Enter ships position, if no GPS is connected.
STNS	Change or delete a station Create a new station
TIME	Set-up time & date
TEST	Make an internal or external test of RM2152
OPTIONS	View identification numbers Position polling ON/off SW version System timers View or set distress telephony mode. View valid telex frequencies View valid telex bands View valid DSC frequencies View or set Message terminal port. View control interface setting
PRINT	View or set Print log On/off
SUN	View or set the sun spot number

Press **FUNC**

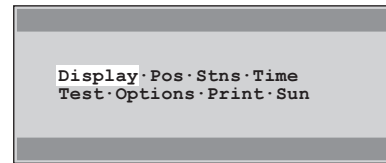

Press **NEXT**

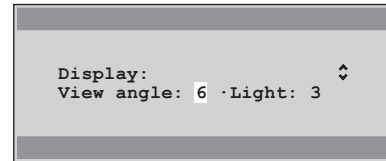

Change with \triangle and ∇ or 0 to 7^{STU}

Move from item to item with \leftarrow and \rightarrow

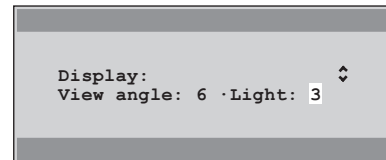

Change with \triangle or ∇ or 0 to 3^{GHI}

Press **NEXT**

5 QUICK DISTRESS CALL

5.1 Undesignated Distress Call

The MF / HF receiver modem RM2152 transmits an undesignated distress call on the distress frequency 2187.5 kHz stating the position of the vessel when **DISTRESS** is activated for at least 3 seconds. The receiver modem will give an constant audible warning, until transmission starts, indicating an attempt to transmit an distress call, and the count down will be shown in the display,

The radio modem sets up the transmitter and the undesignated distress call will be transmitted on 2187.5 kHz.

When the distress call has been transmitted five times in a sequence, the display will indicate that the DSC receiver is in a distress repeating function.

The radio modem waits for four minutes before the next sequence of distress calls are transmitted. In between two such sequences of distress calls, the radio modem scans the distress frequencies searching for an acknowledgement and automatically setting up the receiver RE2100 to 2182.0 kHz at TX and RX frequency, mode H3E, and also waiting for an acknowledgement on telephony.

If you wish to stop the repeated transmissions of the distress calls, simply press **NEXT** or **STOP**. The display shows the called distress frequency.

1. Open **DISTRESS** lid.

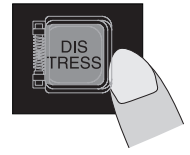

2. Press **DISTRESS** for 3 seconds.

(Modem gives audible warning, and count down is shown in the display.)

Then the undesignated distress call will be send by default on the distress frequency 2187.5 kHz.

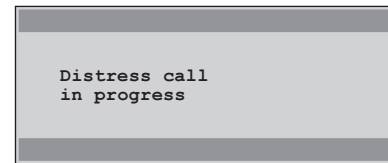

Wait for answer!

(The distress call is autorepeated every 5 minutes on the same distress frequency.)

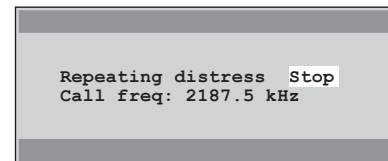

Press **STOP ENT** or **NEXT**

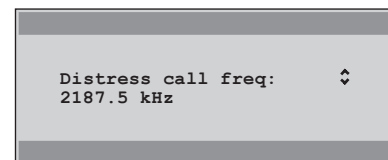

6 STANDARD CALL

The system holds two options for public call: "Standard call" and "Extended call".

The "Standard call" has been developed in order to facilitate the calls, however it does contain some limitations as many of the parameters are selected by default.

A "Standard call" can only be used for ordinary calls where the format specifier is "Individual Stations" (coast or ship stations) and the first telecommand is J3E (telephony as communication mode). The only parameter available will be information on "Work on frequencies" and your position.

6.1 Call without Position and Work Frequencies

If you make a "Standard call" without indication of position and "Work on frequencies", the call will be transmitted without automatic acknowledgement. The result is that you will not receive an automatic acknowledgement from the called station, but your modem will still listen at the call frequency in five minutes in case the called station transmits an acknowledgement manually.

In order to make a "Standard call" without position and "Work on frequency", start by pressing **CALL**. The display will show the top of the call menu and prompt you for station name or station "MID" number.

In order to use the pre-programmed stations, the display should show "Call stn:" in the first line. If "Call MID": is shown, use the left arrow key until "MID" flashes. You the up / down arrow keys to select between "MID" and "stn". When "stn" flashes, enter the initial of the station name and the display will show the first name in the table with this initial. Use the up / down arrow keys to select the name requested.

If the station's name is not pre-programmed, use the "MID" number of the station. In this case, the display should read "Call MID:" in the first line. If the display reads "Call stn:", press the left arrow key until "STN" flashes. Use the up / down arrow keys to select between "stn" and "MID". When "MID" flashes, enter the nine-digit "MID" number of the station to be called.

Press **CALL**

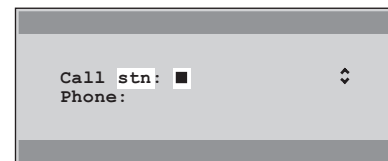

Press **JKL 4 JKL 4 JKL 4**

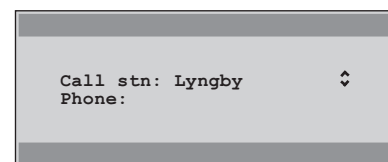

or press **▲** to get display:

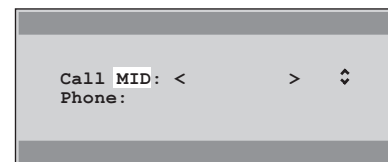

Then press **0 0 DEF 2 ABC 1**
YZ- 9 ABC 1 0 0 0

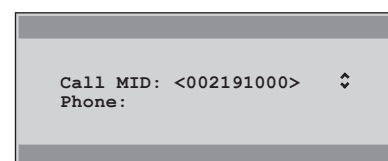

Having selected the station name or entered the station's "MID" number, press **ENT**. If you have selected a coast station (the "MID" number starts with 00), the cursor will jump to the second line and prompt you for the phone number of the subscriber to be called.

If you know the phone number, enter this and confirm by pressing **NEXT**. If not, press **NEXT** in order to select the next display menu.

Entering phone numbers, follows normal international conventions, as known from the normal public phone-net. E.g. calling a subscriber in Denmark, (from the most countries in the world), enter "0045" + wanted national telephone number. This function, however, is not supported by all coast-stations.

The modem will assemble all the pairs of "Call on" frequencies for the station chosen, and show the first pair in the display. You can use the up / down arrow keys to scroll between the frequencies.

If you have selected a pre-programmed coast station, the modem gives you all the pre-programmed frequencies for the called station. But if you have entered a "MID" number of a coast station, the modem gives you all the valid DSC frequencies of the coast station. If you have entered the "MID" number of a ship station, the modem gives you all the valid simplex DSC frequencies for this station.

Select the "Call on" frequencies and press **NEXT**.

The display menu gives you three new options for "Additional message": Position - Work freq - Omit.

Use the left / right arrow keys to select "Omit", press **NEXT**.

The display menu will show the complete call, and prompt you to press **SEND** to start the call.

Press **SEND** and the call will now be sent without information concerning position or work frequencies.

When **SEND** has been pressed, the display menu will read "Call in progress" until the complete call has been transmitted. The display will then show the start of the call menu again. (Entering stn/MID number)

NOTE: If you have made a call within the last five minutes and not received an acknowledgement, the modem will still be waiting for the acknowledgement. If you press **SEND**, the display prompts you to press **SEND** once again in order to cancel the waiting time and repeat the call.

Press 

```
Call MID: <002191000>
Phone: █
```

Press 

```
Getting frqs...
```

```
Call on frqs:
Tx: 2189.5 Rx: 2177.0
```

Press  or 

Press 

```
Additional message:
Position·Work freq·Omit
```

press 

```
INDIVIDUAL CALL
MID : 002191000
Tx : 2189.5 Rx: 2177.0
Cat : Routine
TEL 1: J3E
TEL 2: No info
Press SEND to call
```

If phone number was entered.

```
AUTOMATIC SERVICE CALL
Tx : 2189.5 Rx: 2177.0
Cat : Routine
TEL 1: J3E
TEL 2: No info
Press SEND to call
```

Press 

```
Call in progress
```

```
Waiting for ackn
Press SEND for new call
```

6.2 Call with Work Frequencies

A standard call with work frequencies is normally used in ship-to-ship calls on simplex call frequency. In this case, the station initiating the call selects a pair of frequencies to use in the radio connection between the two stations.

In order to make a standard call with selected work frequencies, proceed as shown in paragraph 6.1 until the display menu prompts you for "Additional message". Use the left / right arrow keys to select "Work freq" and press **NEXT**.

The display menu now prompts you for a channel number or a pair of frequencies.

If you use the channel number, you must use the international ITU telephony channels. Enter the channel number when the cursor flashes to the right of "CH:". Confirm by pressing **ENT** and the pair of frequencies for this channel will be read out in the second line of the display.

If you want to enter the pair of "Work on frequencies" use the left / right arrow keys to select the TX write field, and start by entering the TX frequency. Use **ENT** or right arrow key to move from TX to RX write field and enter the RX frequency. Confirm by pressing **ENT**. If the frequencies disappear, you have entered invalid frequencies and must select a new pair of frequencies.

When the correct frequencies have been selected, press **NEXT** and you will be prompted to press **SEND** in order to start the call.

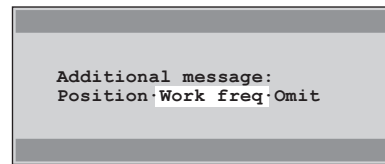

Press **NEXT**

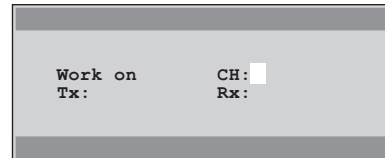

Either:

Press **JKL 4 0 ABC 1 STOP ENT**

causing this window to appear:

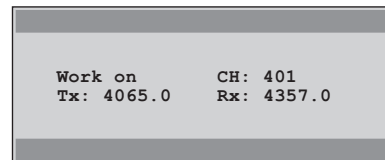

or:

Press **▶**

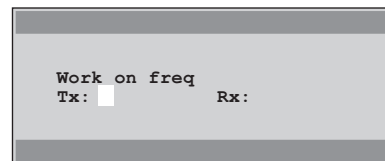

Press **JKL 4 0 PQR 6 MNO 5 DEG . 0 STOP ENT**

Press **JKL 4 GHI 3 MNO 5 STU 7 DEG . 0 STOP ENT**

causing this window to appear:

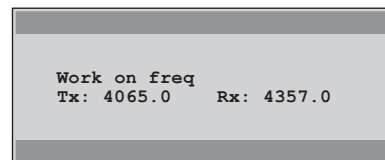

Then press **NEXT**

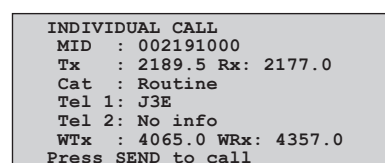

Press **SEND**

NOTE: If you have made a call within the last five minutes and not received an acknowledgement, the modem will still be waiting for the acknowledgement. If you press **SEND**, the display prompts you to press **SEND** once again in order to cancel the waiting time and repeat the call.

```
Call in progress
```

```
Waiting for ackn
Press SEND for new call
```

6.3 Call with Position

A standard call with information about your own position is normally used in connection with calls to coast stations. The coast station will receive your position and find the best free working channel to use. Information about the working channel will be transmitted together with the acknowledgement. Upon reception of the acknowledgement, the modem will automatically set up the transceiver to the work channel and communication can commence.

IMPORTANT!

If the DSC modem is installed with a GPS Satellite Navigator, the ship's position will automatically be updated but if the Navigator is down or not present on board, you will have to enter the ship's position before you initiate the call. Directions as to the encoding of the ship's position, please refer to Chapter 4.2 "Enter / Change Position Information".

In order to make a standard call with selected position, proceed as shown in paragraph 6.1 until the display menu prompts you for "Additional message". Use the left / right arrow keys in order to select "Position" and press **NEXT**.

```
Additional message:
Position·Work freq·Omit
```

Press **NEXT**

```
INDIVIDUAL CALL
MID : 002191000
Tx : 2189.5 Rx: 2177.0
Cat : Routine
Tel 1: J3E
Tel 2: No info
Pos : N57°01' E009°53'
Press SEND to call
```

Press **SEND**

If current position is not valid, the position will not be displayed, and the receiver will get S99°99' W999°99'.

The display will prompt you to press **SEND** in order to start the call.

Press **SEND** and the call will be sent with information about the position.

When **SEND** has been pressed, the display menu will read out "Call in progress" until the complete call is transmitted. Then the display will return to the start of the call menu.

```
Call in progress
```

NOTE: If you have made a call within the last five minutes and not received an acknowledgement, the modem will still be waiting for the acknowledgement. If you press **SEND**, the display prompts you to press **SEND** once again in order to cancel the waiting time and repeat the call.

```
Waiting for ackn
Press SEND for new call
```

7 ADVANCED DSC CALLS

The extended call menu can be used to create a call in situation where you can not use the standard call menu. The extended call menu contains all the types of calls that can be created by the DSC modem.

In order to start an extended call, press **CALL** followed by **EDIT**. The display will show the start of the extended call menu. This menu will prompt you for the first selection. You can select between three different types of calls: Distress, All ships or Selective.

Tx menu. Enter correct data instead of examples shown in *italics*:

Type of call	Options	Other data transmitted	Telecom 1	Ackn.
DISTRESS	UNDESIGNATED DISABLE SINKING LISTING (CAPSIZE) GROUNDING COLLISION FLOODING FIRE ABANDONING PIRACY MAN OVER BOARD	Position UTC time for position ... to be entered manually if not obtained from e.g. a GPS.	SSB telephony AM telephony FEC	?

EXTENDED Tx call started from "EXTENDED" in the table on the previous page. Enter correct data instead of examples shown in *italics*:

Type of call	Address	Options	Category	Telecom 1	Telecom 2	Add. msg.	Ackn.	
INDIVIDUAL Shore:	<i>001234567</i>	No info: Call shore station	Routine	SSB telephony	No info		Yes	
Ship:	<i>123456789</i>			SSB telephony	No info	No info	Yes	
GROUP	<i>012345678</i>			AM telephony	MEDICAL	Position	No	
G.AREA	<i>N:57° d02°</i> <i>W:009° d03°</i> The data in the example gives the area: <i>N:55..57°</i> <i>W:6..9°</i>			POLLING No info FAX ARQ FEC TTY RX TTY TAPE MORSE SHIP POSITION DATA	AIRCRAFT	Work. frequency	No	
			ROUTINE URGENCY DISTRESS SAFETY BUSINESS	Unable to comply	V21 V22 V22 BIS V23 V26 V26 BIS V26 TER V28 TER V32	No reason Congestion Busy Queue Station Barred No operator Temporary engaged Equipment not No channel No mode No info		
ALL SHIPS			DISTRESS SAFETY URGENCY	Same as above	Same as above	Work. frequency	No	
DISTRESS RELAY	Type of address	Address	Ship in distress	Distressed ship's MMSI	Distress rela	As for DISTRESS in table Tx Call	As for DISTRESS in table Tx Call	As for DISTRESS in table Tx Call
	ALL SHIPS	All ships	UNKNOWN					
	INDIVIDUAL	<i>001234567</i>	KNOWN	<i>123456789</i>				
DISTRESS ACK	Type of address	Address	Distressed ship's MMSI		Distress ack	As for DISTRESS in table Tx Call	As for DISTRESS in table Tx Call	As for DISTRESS in table Tx Call
	ALL SHIPS	All ships	<i>123456789</i>					

MMSI address rule:

Shore station numbers start with 00, group numbers start with one 0, ship numbers start with a digit 1-9.

8 RECEIVED MESSAGE BOOK

Received message book is a menu by which a reference for the last 20 distress calls and the last five ordinary calls, distress relay calls, or acknowledgements can be made. When you use a reference you can get all the information concerned with the received call, or you may want to change some information and send it back as a manual acknowledgement or as a distress relay.

All received calls will automatically be deleted from the received message book after 48 hours.

8.1 Looking for an Ordinary Call

In order to look for one of the last five ordinary calls, press **RX MSG**. The display will prompt you for what type of incoming calls you wish to look at - Ordinary Calls or Distress Calls. Use the left / right arrow keys in order to select "Ordinary" and press **NEXT** to confirm.

The display will now show the date and time for the last incoming call. If you use the down arrow, you can see date and time for the four previous ordinary calls. The up arrow key will take you back to the last incoming call. In addition to date and time, the type of call received by the mode as well as the communication mode used will also be available. At the end of the first line, you will see the basic information for the incoming call. The display will show "Call", "Ackn" or "Error".

"Call" indicates that the modem has received a call to your station or a distress acknowledgement from another station. "Ackn" indicates that the modem has received an acknowledgement from a call sent by your station. "Error" indicates that the modem has received a call or an acknowledgement, but in the call information, a block error has been found.

After the "Call" and asterisk might appear. If the asterisk is found, it implies that the modem has transmitted an automatic or manual acknowledgement for this call.

Press **RX MSG**

```
Type of incoming call:
Ordinary·Distress
```

Press **NEXT**

```
26 Jan 00 12:20 call
Individual J3E
Freq: 4207.5 kHz
MID : 999595374
Cat : Routine
Tel 2 : No info
No work freq or position
```

8.1.1 Send Manual Acknowledgement

When you press **NEXT** and read the information concerning the incoming call, the display menu will prompt you for an acceptance or a change of the information before you send the manual acknowledgement. If you wish to change the information, use the right arrow key until "Change" flashes. Press **NEXT** to confirm your choice and the menu will change the first telecommand to "Unable to comply". You can not change this but if you press **NEXT**, you must select the reason (second telecommand) in order to explain why you are unable to comply. You will be given the following options:

- No reason
- Busy
- Unable to use proposed mode
- Unable to use proposed channel
- Equipment disabled
- Operator temporary unavailable
- No operator available
- Station barred
- Queue indication
- Congestion at maritime switching centre

Use the up / down arrow keys in order to select your choice and press **NEXT**. The display menu will now prompt you to press **SEND** to transmit the acknowledgement. This is the same prompt you will be given if you have selected "Accept" instead of "Change information".

Press **SEND** and the modem will start transmitting the acknowledgement on the call frequency. If you have not changed the information, the communication transceiver will automatically set up the work frequencies or the channel after transmission of the acknowledgement.

After having sent the ackn, the original call, from the RX-MSG book will be shown again, with an asterisk added to the end of the first line, - indicating that an ackn has been sent.

8.2 Looking at a distress call

If you wish to search for an incoming distress call, start by pressing **RX MSG** and the top of the RX message book menu will show up and prompt you for "Ordinary" or "Distress call". Use the right arrow key until "Distress" flashes. Press **NEXT** to confirm your choice.

The display will now show the last incoming distress call. If you wish to look at one of the previous 19 incoming distress calls, use the down arrow key and scroll down the list. The display shows you information such as date and time for the incoming distress call and the nature of distress. The display also shows if the station has sent an acknowledgement for the received distress call. In this case an asterisk will be placed after "Call". If the distress call was received with a block error, i.e. that some of the information in the distress call was not received, "Call" will be replaced by "Error". In this case, some of the information will be wrong.

Press **NEXT**

```
Type of Answer:
Accept·Change info
```

Press  **NEXT**

```
New working freq
Not able to comply
```

Press **NEXT**

```
Reason:
No reason
```

Press **NEXT**

```
Acknowledgement
Individuel
MID : 999595374
Cat : Routine
Tel 1: Unab to cply
Tel 2: No reason
WTx : WRx :
Press SEND to acknowledge
```

Press **SEND**

```
Call stn: <999595374>
Acknowledge in progress
```

Press **RX MSG**

```
Type of incoming call:
Ordinary·Distress
```

Press  **NEXT**

```
28 Jan 00 12:41 call
Freq : 2187.5 kHz
Ship : 999595378
Nat : Undesignated distress
TmPo : 12:40 N57°01' E009°53'
Comn : H3E
```

8.2.1 Send Manual Distress Acknowledgement.

To send a manual distress acknowledgement, start by pressing **RX MSG** and select “Distress”. Go to the incoming distress call that you wish to acknowledge and press **NEXT**. After having pressed **NEXT**, the display will prompt you for type of answer. You can select between “Distress acknowledgement” or “Distress relay”.

Use the left arrow key to select “Ackn” and press **NEXT** to confirm your choice. The display will now show the whole content of the call and prompt you to press **SEND** to start transmitting the acknowledgement.

Press **SEND** and the modem will start an all ships call with first telecommand as distress acknowledgement. After the call, the communication transceiver will automatically be set to distress telephony frequency 2182 kHz.

Press **RX MSG**  **NEXT**

Press **NEXT**

```
Type of Answer:
Distress:ackn:relay
```

Press **NEXT**

```
DISTRESS ACKNOWLEDGE
All ships
Freq : 2187.5 kHz
Ship : 999595374
Nat : Undesignated distress
TmPo : 15:21 N57°01' E009°53'
Comm : H3E
Press SEND to acknowledge
```

Press **SEND**

8.2.2 Send a Manual Distress Relay

To send a distress relay, you must start by pressing **RX MSG** and select “Distress”. Locate the incoming distress call you wish to send as distress relay and press **NEXT**. After having pressed **NEXT** again, the display menu will prompt you for type of answer. You can select between distress acknowledgement or distress relay.

Use the left arrow key in order to select “Relay” and press **NEXT** to confirm your choice. The display menu will prompt you for call on frequencies. The modem takes the frequency on which the distress call was received as default, but you may enter a new pair of frequencies, and then press **ENT**. If the frequencies disappear from the writing field, the pair of frequencies is invalid and you must select another pair.

Press **NEXT** and the display menu will prompt you to press **SEND** in order to start transmission of the distress relay. When you press **SEND** the modem will send an all ships call with the first telecommand as distress relay.

Press **RX MSG**  **NEXT**

Press **NEXT**

```
Type of Answer:
Distress:ackn:relay
```

Press 

Press **NEXT**

```
Call on freq:
Tx: 2187.5 Rx: 2187.5
```

Press **NEXT**

```
DISTRESS RELAY
All ships
Freq : 2187.5 kHz
Ship : 999595378
Nat : Undesignated distress
TmPo : 12:40 N57°01' E009°53'
Comm : H3E
Press DISTRESS to relay
```

Press **DIS TRESS** for 3 seconds.

Display will now count down 3 - 2 - 1 and the call will be sent.

9 SCANNING - DSC WATCH RECEIVER

The MF/HF DSC Watch Receiver has a scanning facility that can retrieve scanning information from up to 6 frequencies. Scanning can be stopped. It is also possible to edit the scanning table while the RM2152 is still scanning. Also a "step" facility is available, in which the RM2152 watch Receiver can tune to each of the, minimum 3 and maximum 6, entries in the scanning table. Frequencies 2187,5 kHz and 8414.5 kHz are always in the scanning table, together with at least one of the other distress-frequencies 4207,5 kHz, 6312,0 kHz, 12577,0 kHz and 16804,5 kHz.

9.1 Scanning start/stop

In order to go to the top of the scan menu press **SCAN** and one of two menus will be displayed depending on whether the scanner runs or has stopped.

To start scanning, press **NEXT** when "Start" flashes and to stop scanning, press **NEXT** when "Stop" flashes.

Press **SCAN**

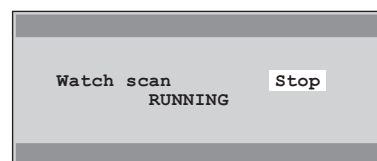

Press **NEXT**

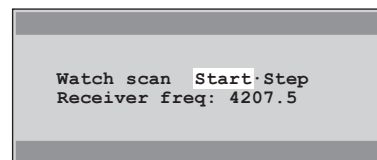

Press **NEXT**

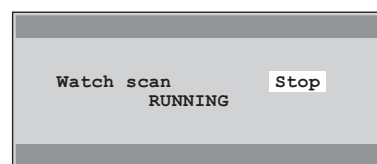

9.2 Stepping

Stepping is tuning the receiver to different frequencies specified in the scan program.

Enter the stop/step menu as described in section 9.1

Use the left / right arrow keys until "Step" flashes. Press **NEXT** and the scan step menu will be displayed.

Use the up / down arrow keys to select the desired frequency.

Press **NEXT** when satisfied.

NOTE: If there is no valid frequency in the chosen entry number, the number flashing will take the next valid program number.

Press  **NEXT**

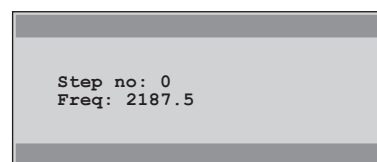

Press 

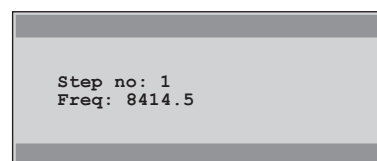

Press **NEXT**

9.3 Scan Editing

In order to edit the different scan programs, press **SCAN** followed by **EDIT**.

In this menu, you can edit existing scan program. By pressing the right arrow key, it is possible to move between the different fields in the display. The contents of the fields can be changed by using the up/down keys. However, content of entry no. 0 and 1 can not be changed.

In this example, select "FREQ" and use the up / down arrow keys to select between 6 pre-programmed DSC Distress - frequencies.

When a frequency has been chosen by pressing **ENT**, notice that the entry number has incremented to the next entry, ready for next input. From there, simply repeat the insertion of the frequencies you wish to scan and press **ENT** after each entry.

Press **NEXT** when the editing is completed. The modem will return to one of the two main scan menus depending on whether or not the modem is scanning.

If you want to remove a frequency from the scanning table: In stead of selecting a frequency, using the up/down keys, in stead use the left arrow key to delete the existing frequency. Be sure that the cursor remains in the "frequency" field, then press **ENT**. The entry has now been deleted from the scanning table. The appropriate entry now appears with an empty "frequency" field. Entry "0" and "1" can not be deleted

Press **SCAN** **EDIT**

```
Edit no: 2
Freq: 4207.5
```

Press **▲** **▶**

```
Edit no: 3
Freq: 6312.0
```

Press **▲** **▲**

```
Edit no: 3
Freq: 16804.5
```

Press **STOP** **ENT**

```
Edit no: 4
Freq: 12577.0
```

Press **NEXT**

```
Watch scan      Start:Step
Receiver freq:  8414.5
```

10 SCANNING - DSC/TELEX RECEIVER

The MF/HF DSC telex modem RM2152 has an advanced scanning facility that can retrieve scanning information from 10 different scanning programs. Each program contains up to six frequencies in a frequency or channel format. Only one scanning program is activated at a time, and can at any time be stopped or edited. It is also possible to edit in the scan programs while the RM2152 modem is scanning. Also a "Step" facility is available in which the RM2152 modem can tune to each of the six entries in each scan program.

10.1 Scanning

In order to go to the top of the scan menu press **SCAN** and one of two menus will be displayed depending on whether the scanner runs or has stopped. If the keyboard has been used for five minutes, only one of the two menus will be shown. It is only a received DSC call that can overwrite the top of the scan menu.

To start scanning, press **NEXT** when "Start" flashes and to stop scanning, press **NEXT** when "Stop" flashes.

The Scan prg:No. indicates which program to use. If you wish to change the program No., stop the scanner and use the left / right arrow keys until the program number flashes. Use the up / down arrow keys to change this number or enter the number on the numerical keyboard. When the correct scan program number is shown, use the left / right arrow keys, and when "Start" flashes press **NEXT**.

NOTE: If the chosen scan programme does not contain any scanning frequencies, an error message will appear in the display. "No valid freq".

In order to stop the scanner, press **NEXT**, and the display will show that the scanner has stopped. The second display line indicates which receiving frequency, the receiver is currently tuned to.

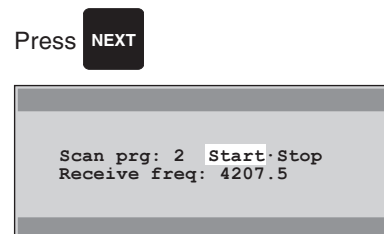
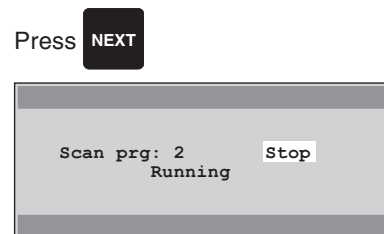
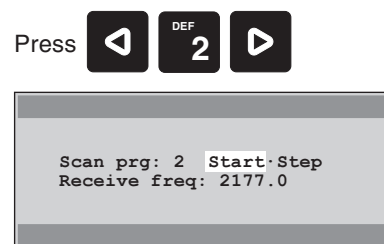
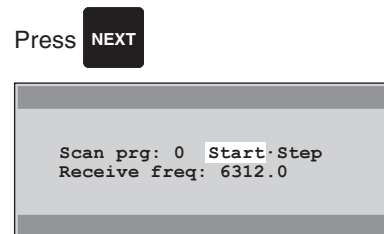
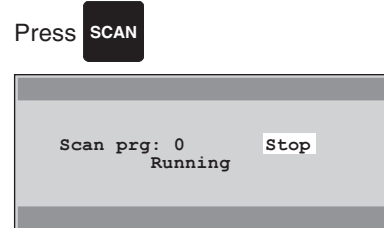

10.2 Stepping

Stepping is tuning the receiver to different frequencies specified in the scan programs.

Use the left / right arrow keys until "Step" flashes. Press **NEXT** and the scan step menu will be displayed.

Use the up / down arrow keys to change the number of Nos. so that the different entries in each program can be stepped. Use the left / right arrow keys to make the "Step prg" flash. Use the up / down arrow keys to change the number of "Step prg".

Press **NEXT** when satisfied.

NOTE: If there is no valid frequency in the chosen program number or entry number, the number flashing will take the next valid program number.

10.3 Scan Editing

In order to edit the different scan programs, press **SCAN** followed by **EDIT**.

In this menu, you can edit existing scan programs or you can build new ones. By pressing the left / right arrow keys, it is possible to move between the different fields in the display. The programme and number can be changed by using the up / down arrow keys. When the right programme and number appears, move the cursor to "CH" or "Freq" depending on which of the two you want to put into the scan program.

In this example, select "FREQ" and enter a new frequency to the scan program or use the up / down arrow keys to select between all pre-programmed valid DSC frequencies.

When a frequency has been chosen by pressing **ENT**, notice that the number increments to the next entry, ready for next input. From there, simply repeat the insertion of the frequencies you wish to scan and press **ENT** after each entry. You can also enter a channel number when the cursor is flashing by "CH". Only the valid DSC channels 226 to 233 can be chosen.

Press  **NEXT**

```
Step prg: 2 no: 0
Ch:       Freq: 4207.5
```

Press 

```
Step prg: 2 no: 1
Ch:       Freq: 2177.0
```

Press **NEXT**

Press **SCAN** **EDIT**

```
Edit prg: 2 no: 2
Ch:       Freq: 2177.0
```

Press   

```
Edit prg: 2 no: 3
Ch:       Freq: 
```

Press 

```
Edit prg: 1 no: 3
Ch:       Freq: 6312.0
```

Press **STOP** **ENT**

```
Edit prg: 2 no: 4
Ch:       Freq:
```

Press **NEXT** when the editing is completed. The modem will return to one of the two main scan menus depending on whether or not the modem is scanning.

NOTE: If a message terminal is connected to the modem and is controlling the scanning, the display menu will show what type of scanning (ARQ or DSC), the message terminal is controlling.

At any time, you can press **SCAN** followed by **NEXT** to stop the scanning controlled by the message terminal.

Press **NEXT**

```
Scan prg: 2 Start Step  
Receive freq: 6312.0
```

```
Scanning ARQ from  
Message Terminal
```

Press **SCAN**

```
Scan running  
Press NEXT to stop
```

Press **NEXT**

```
Scan prg: 2 Start Step  
Receive freq: 2177.0
```

11 TEST FUNCTION

The test function is used to test the internal and / or external functions on the DSC modem. When you start a test, an internal program will run a test sequence to test the modem for proper function. If the program finds a function that is not working, the display will show an error message.

11.1 Internal Test

In order to start an internal test, press **FUNC** and use the left / right arrow keys to select "Test". Press **NEXT** to confirm your choice. The display will prompt you for internal or external test. Use the left / right arrow keys until "Internal" flashes, the press **NEXT**.

When internal test is running, the test program starts testing the communication link (SP-BUS) between the modem and the transceiver. If the connection is bad, the display will flash up with "SP-BUS Error" and stop the test. If the communication on SP-BUS works properly, the communication transceiver gives a beep in the loudspeaker and the test program starts testing the GMDSS Distress Alarm Unit. If the alarm is connected to the system and it works properly, the internal test is passed. In case the alarm unit was not installed or not working properly, the display shows "No remote alarm" and the test program will return to the "Type of test" selection menu.

11.2 External Test

The external test is used to test DSC call and receive function.

Start by pressing **FUNC** and use the left / right arrow keys to select "Test". Press **NEXT** to confirm your choice. The display prompt you for internal or external test. Use the left / right arrow keys until "External" flashes, the press **NEXT**.

The display will prompt you for the nine-digit "MID"-number for the station that you want to use in the test. Enter the nine-digit number. The number has to be one of your pre-programmed stations in the station register. If you use another number the display will show "Table not found". You must then press **NEXT** and enter a nine-digit number from the pre-programmed stations.

If the number is known to the modem, the test program will

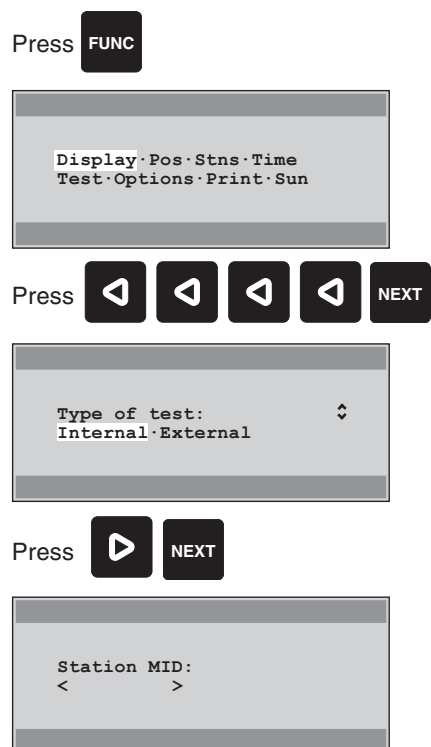
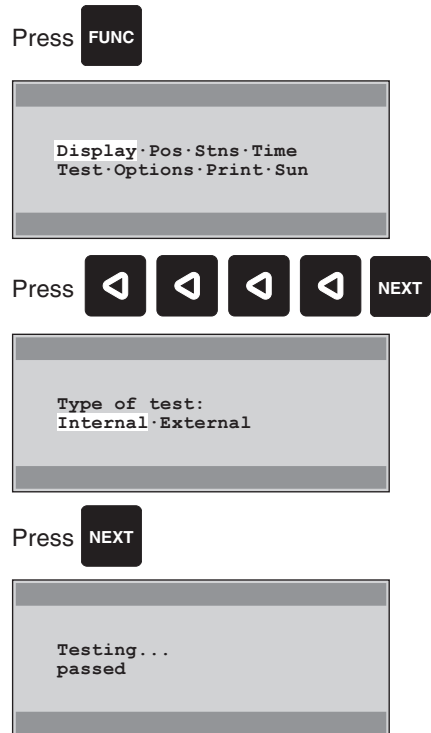

use the best frequency of the pre-programmed call frequencies from the station table and start the transmitter on that frequency. When the transmitter is ready, and individual call with category "Vital safety" and first telecommand as "Test" will be sent.

After having transmitted the call, the modem will be listening on the receiver frequency for 4½ minutes waiting for an acknowledgement from the coast station.

Press **0** **0** ^{DEF}**2** ^{ABC}**1** ^{YZ-}**9**

^{ABC}**1** **0** **0** **0**

Press **NEXT**

```
Testing...
passed
```

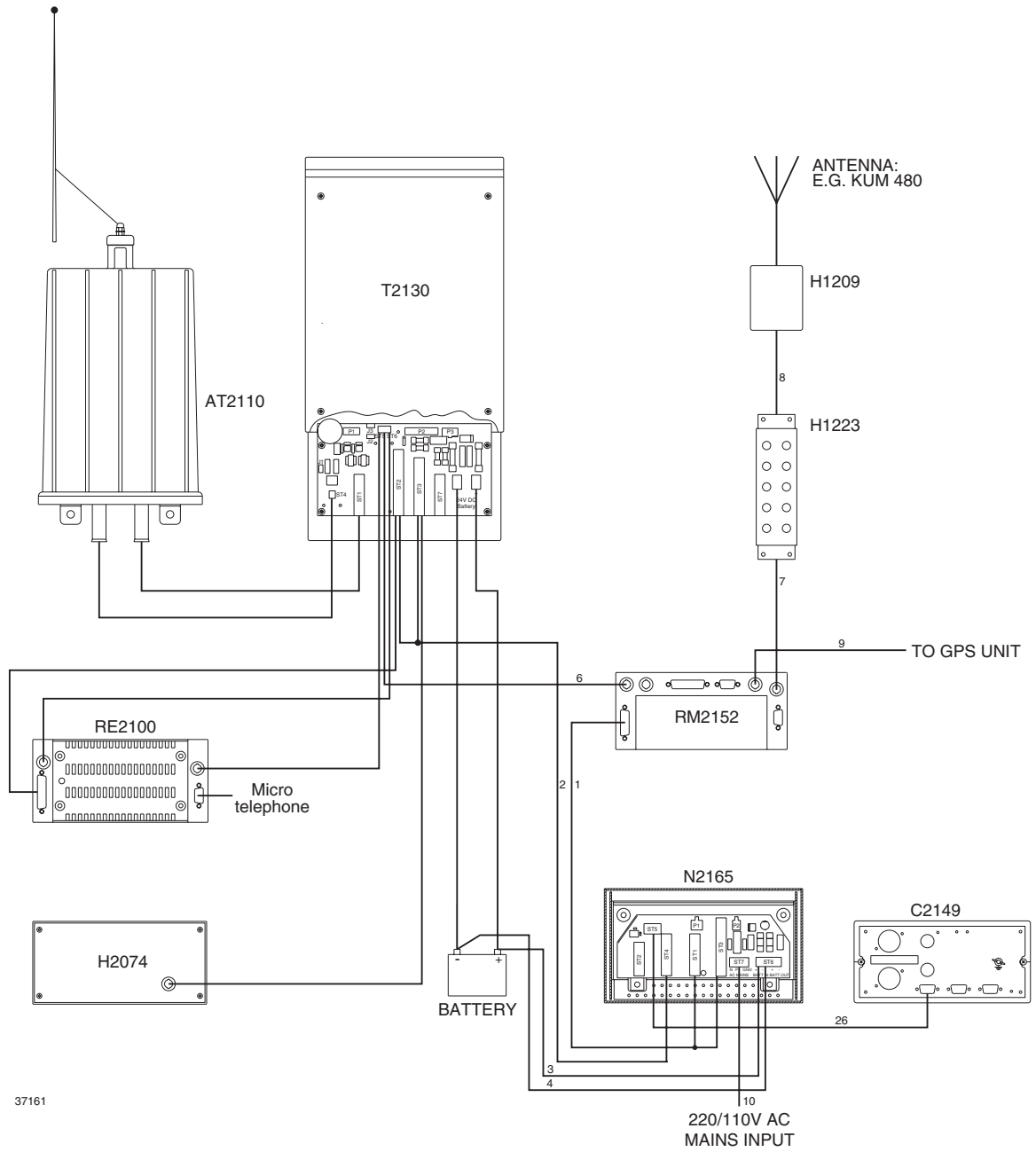

A CABLES BETWEEN CABINETS

HF SSB 250W DC WITH DSC WATCH RECEIVER RM2152 AND N2165.

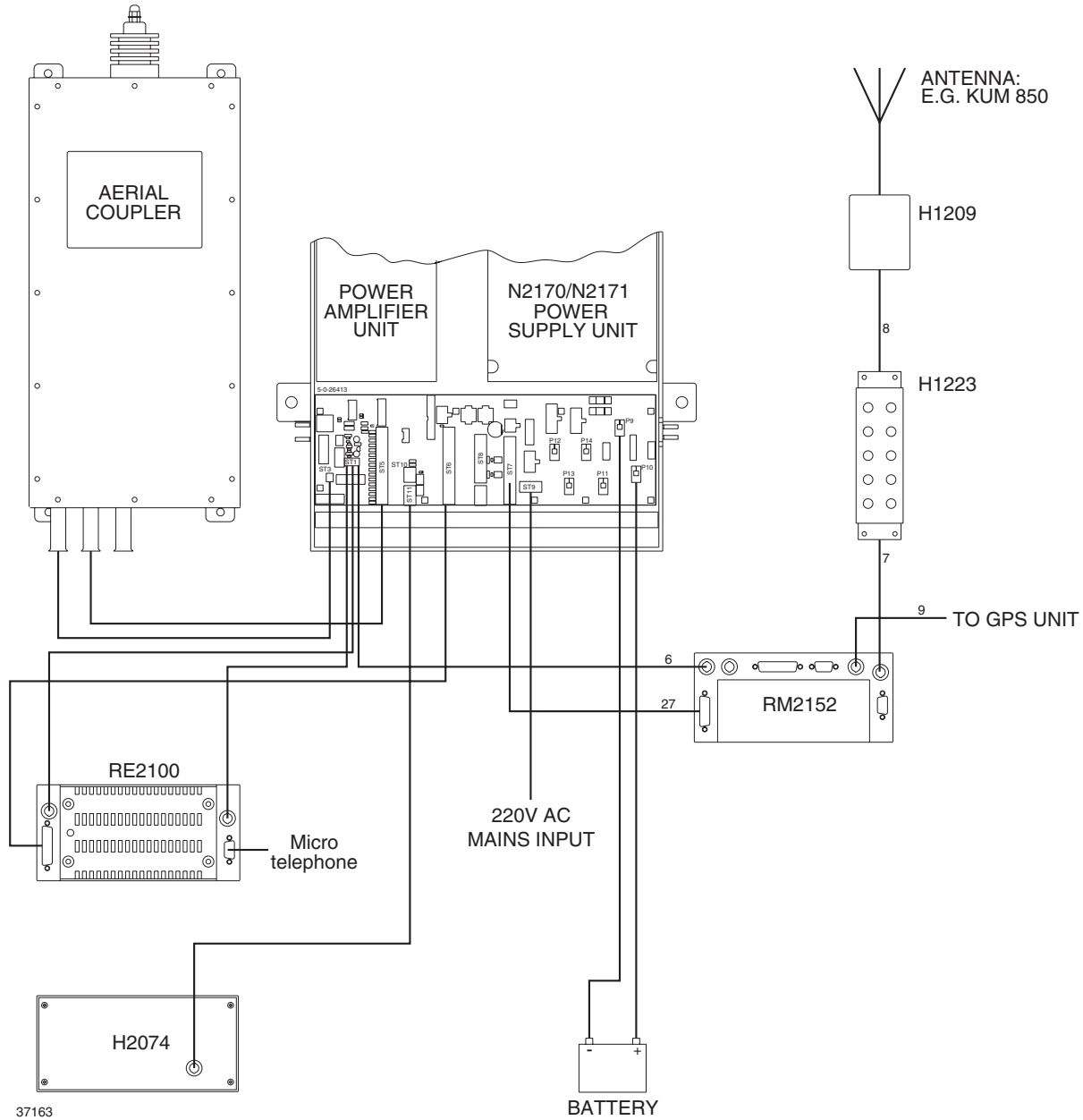

37161

HF SSB 600W AC/DC WITH DSC WATCH RECEIVER RM2152.



B TABLE OF INFORMATION SYMBOLS ABOVE 100

Symbol No	End of sequence	Format specifier	Category	Nature of distress	1st tele-command	2nd tele-command
100			Routine	Fire, explosion	F3E/G3E simplex TP	No reason given
101				Flooding	F3E/G3E duplex TP	Congestion at maritime switching centre
102		Geographical area	Important safety	Collision		Busy
103				Grounding	Polling	Queue indication
104	Phasing Rx-0 position			Listing in danger of capsizing	Unable to comply	Station barred
105	Phasing Rx-1 position			Sinking	End of call	No operator available
106	Phasing Rx-2 position		Ship business priority	Disable and adrift	Data	Operator temporarily unavailable
107	Phasing Rx-3 position			Undesignated distress		Equipment disabled
108	Phasing Rx-4 position		Safety	Abandoning ship		Unable to use proposed channel
109	Phasing Rx-5 position			Piracy / Armed robbery	J3E TP	Unable to use proposed mode
110	Phasing Rx-6 position	Marking sequence in VHF/UHF service	Urgency	Man over board	Distress acknowledgement	Ships and aircrafts according to Resolution No. 18
111	Phasing Rx-7 position				H3E TP	Medical transport
112		Distress	Distress	EPIRB emission	Distress relay	Pay-phone/public call office
113					F1B/J2B TTY-FEC	Facsimile/data
114		Ships having common interest (group call)				
115					F1B/J2B TTY-ARQ	Data V.21
116		All ships			F1B/J2B TTY rec.	Data V.22
117	Request acknowledgment					
118					Test	Data V.22 bis
119					F1B/J2B TTY	Data V.23
120		Individual station			A1A Morse TR	Data V.26 bis
121		Research for national noncalling purposes			Ship's position or registration of location updating	Data V.26 ter
122	Call is an acknowledgement					
123		Individual station semiautomatic-/automatic VHF service			A1A Morse	Data V.27 ter
124		Signalling sequence in automatic VHF/UHF service			F1C/F2C/F3C FAX	Data V.32
125	Phasing Dx pos.					
126	Unused info				No information	No information
127	Do not expect acknowledgment					



S.P. RADIO A/S • Porsvej 2 • PO Box 7071 • DK-9200 Aalborg SV • Denmark
Phone: +45 9634 6100 • Fax: +45 9634 6101 • Telex: 69789 SPRAD DK
E-mail: sailor@sailor.dk • Web: www.sailor.dk